

prof. Matemko

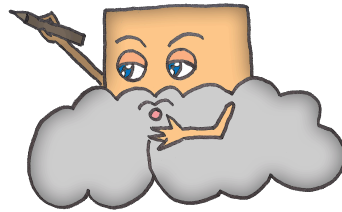

Oglišča mnogoterca

Mnogoterec je dan z mrežo. Nekatera oglišča mreže so že označena z zaporednimi številkami. V vsak neoznačen krog vpiši številko tako, da bodo oglišča na mreži, ki predstavljajo isto oglišče telesa, označena z isto številko.

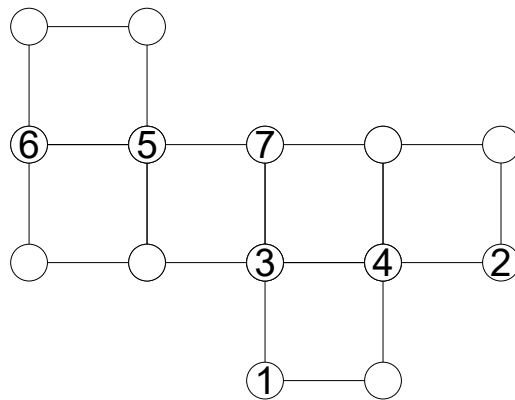

Odgovor

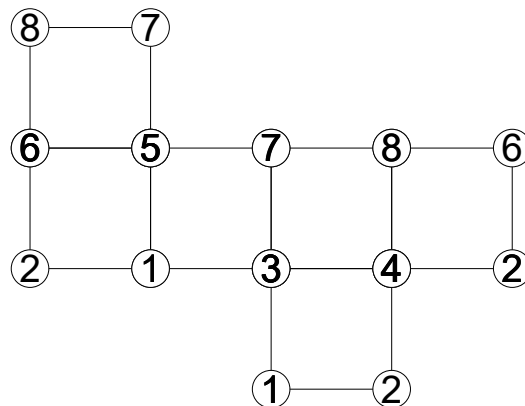

MATHEMA

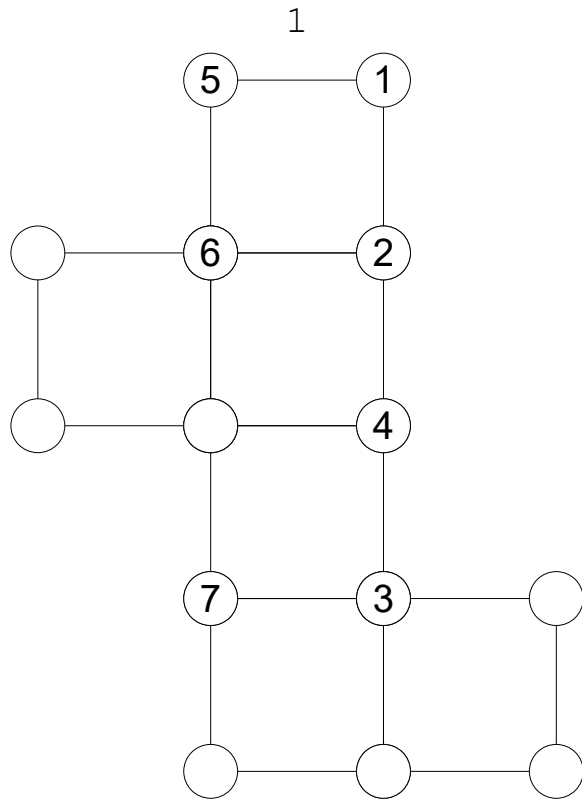

2

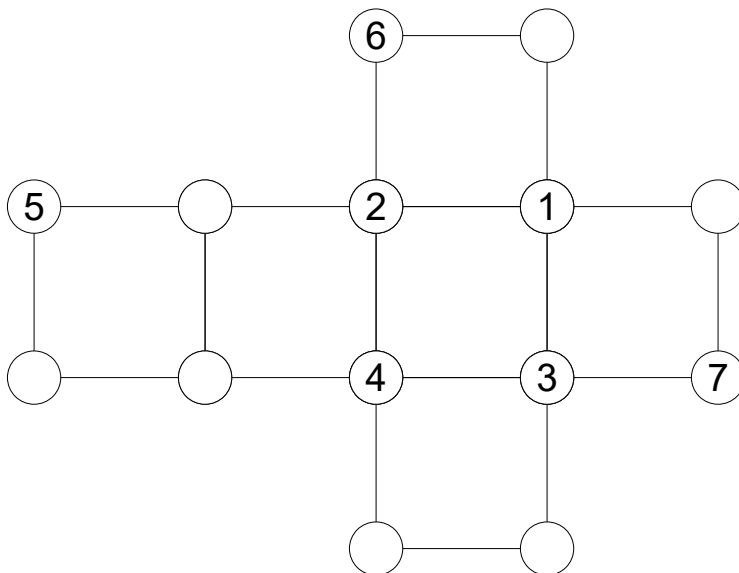

3

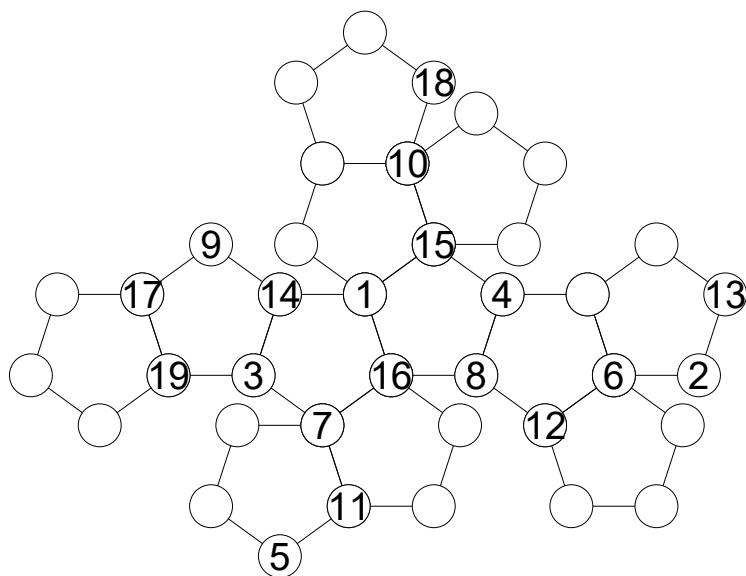

4

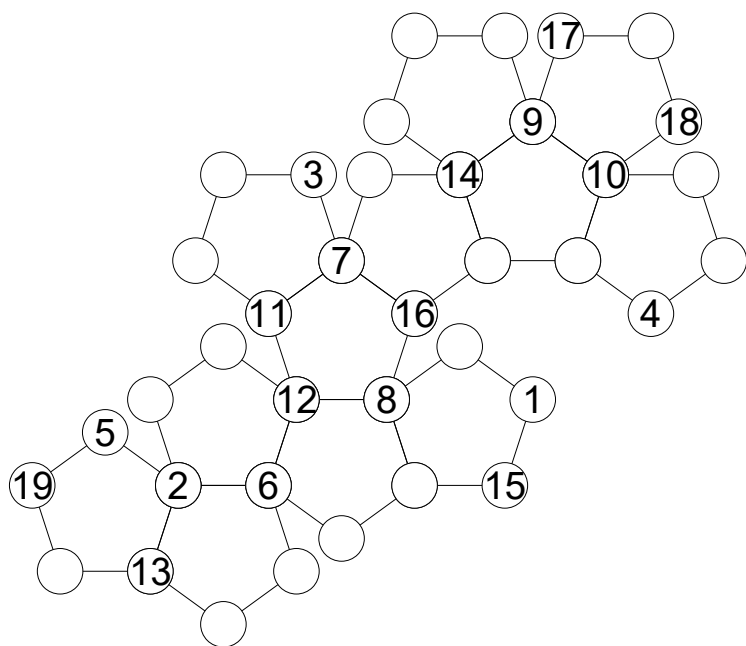

5

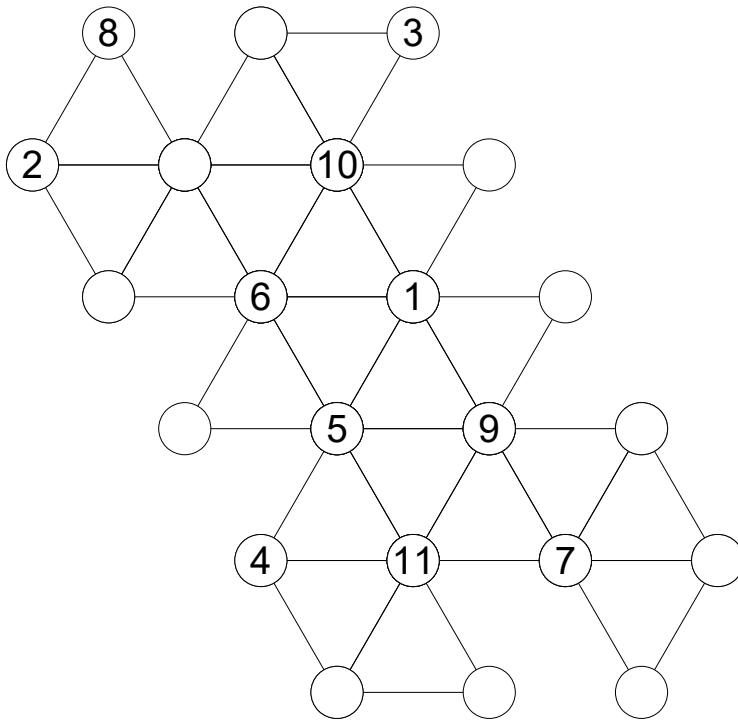

6

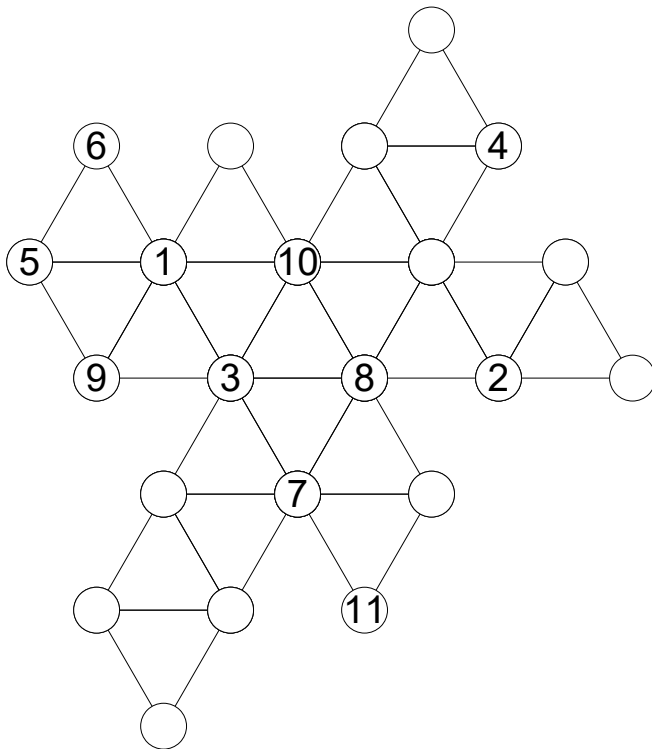

7

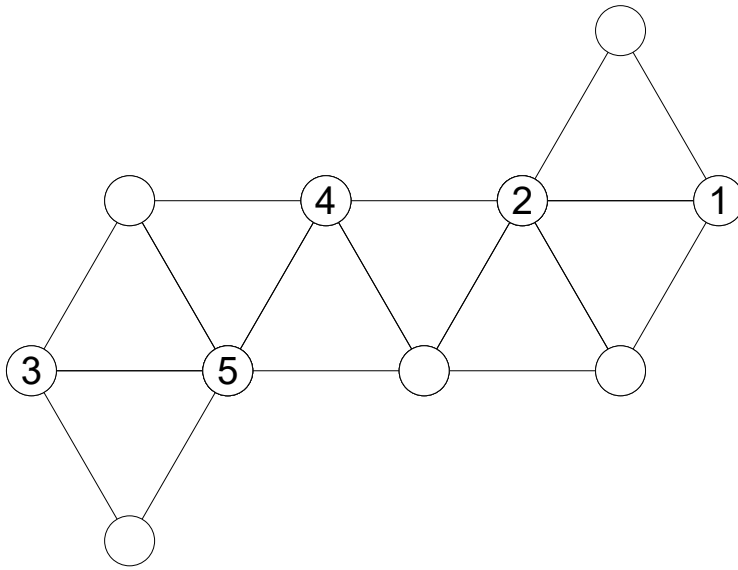

8

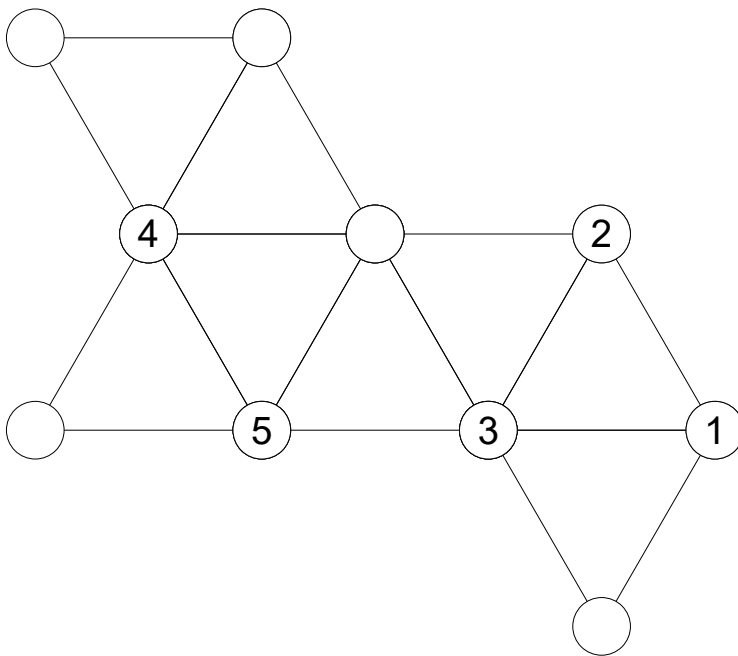

9

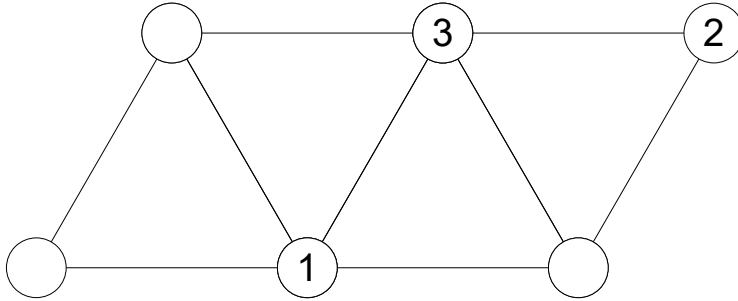

10

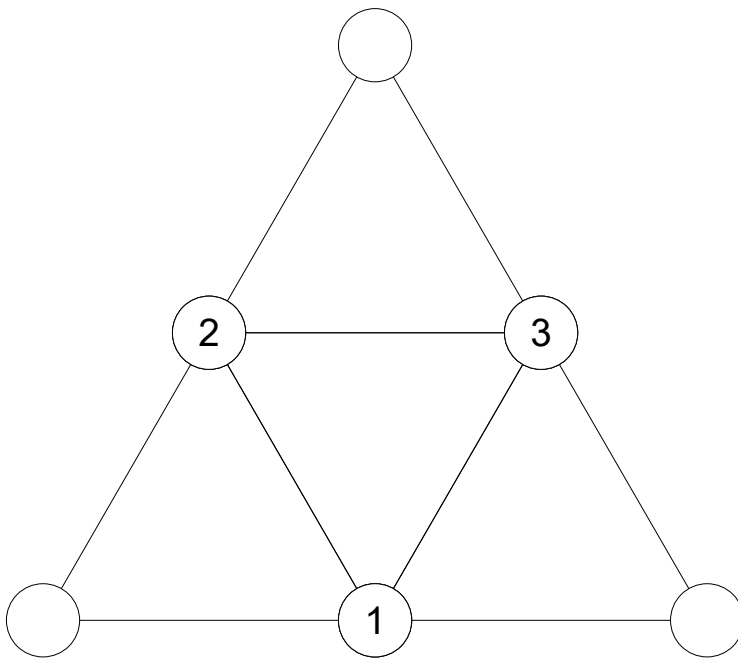

11

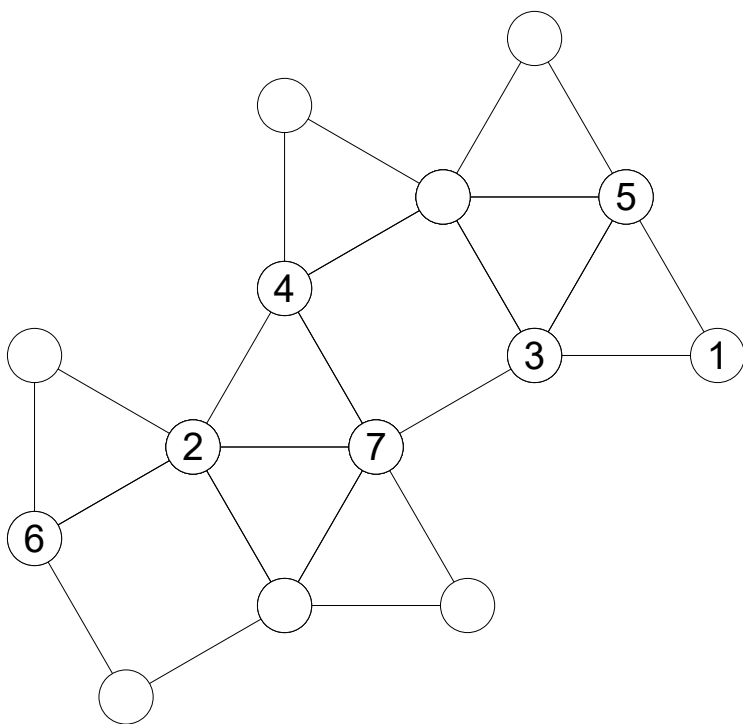

12

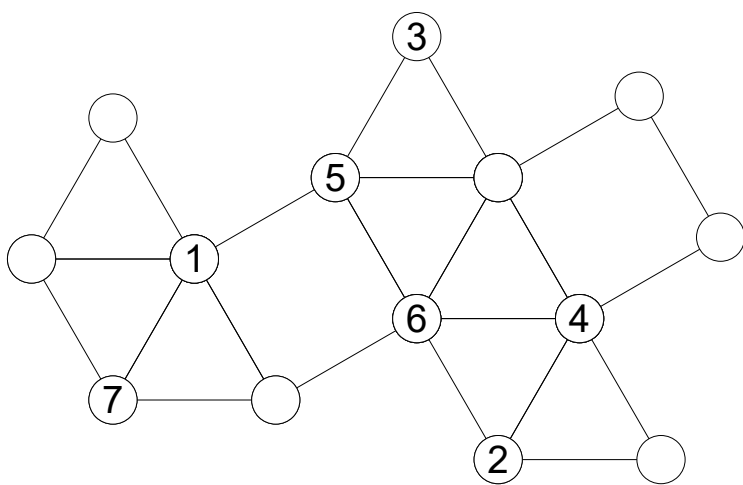

13

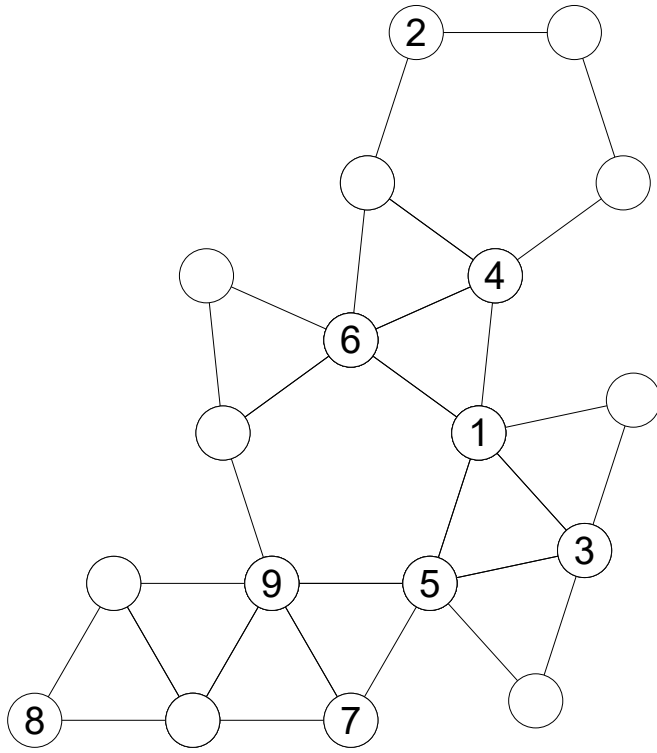

14

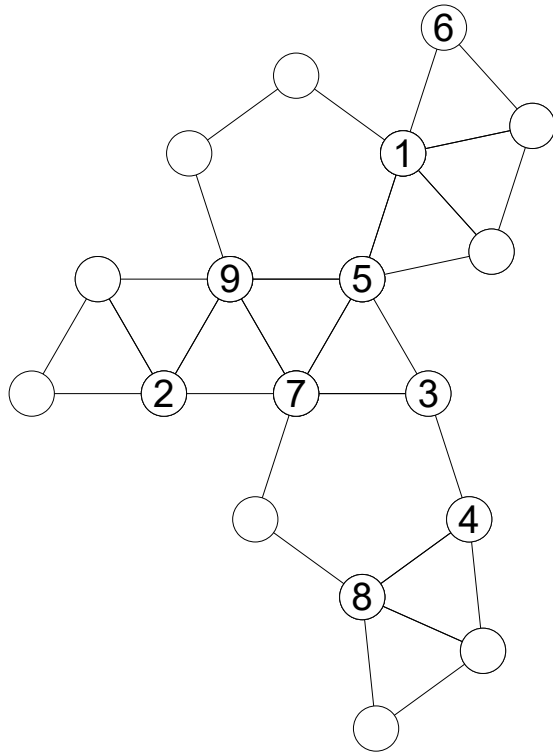

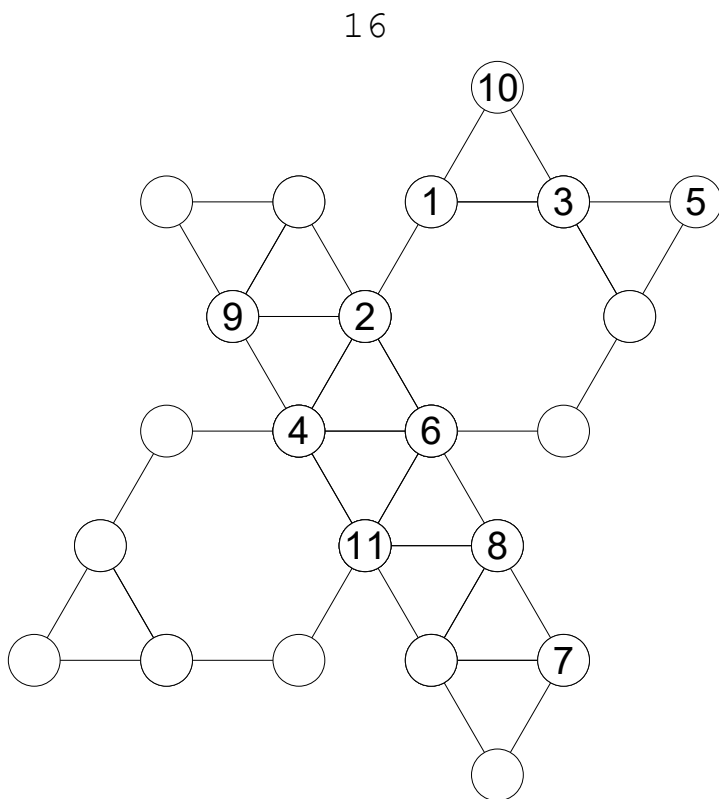
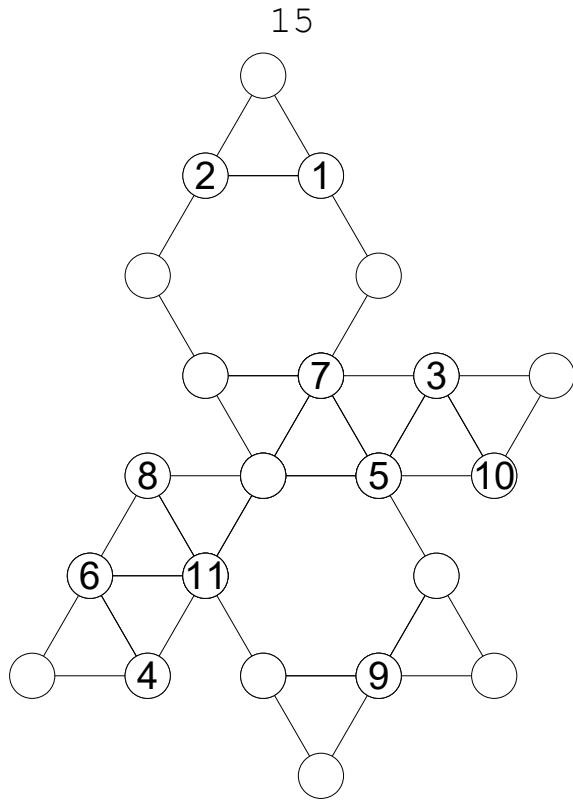

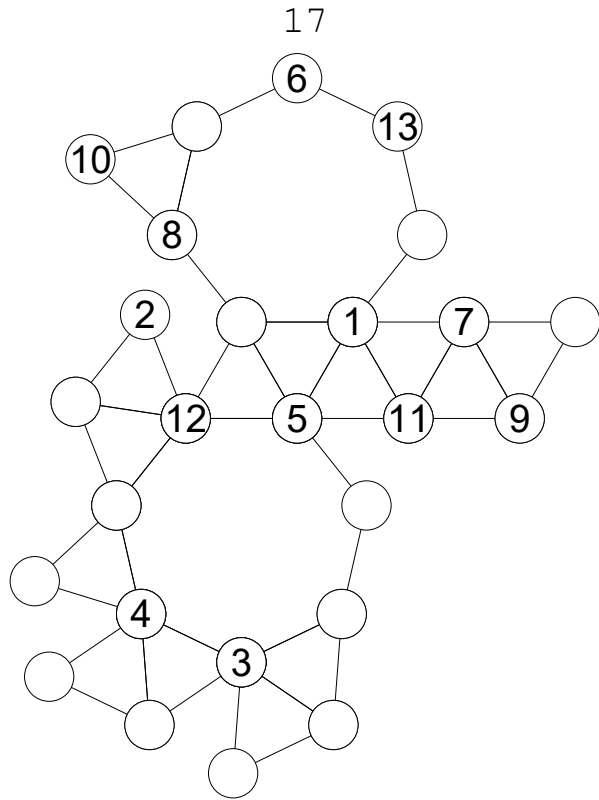

18

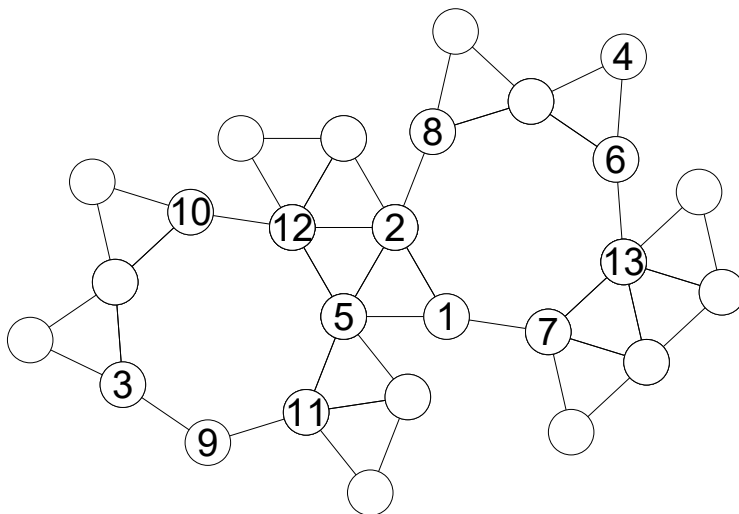

19

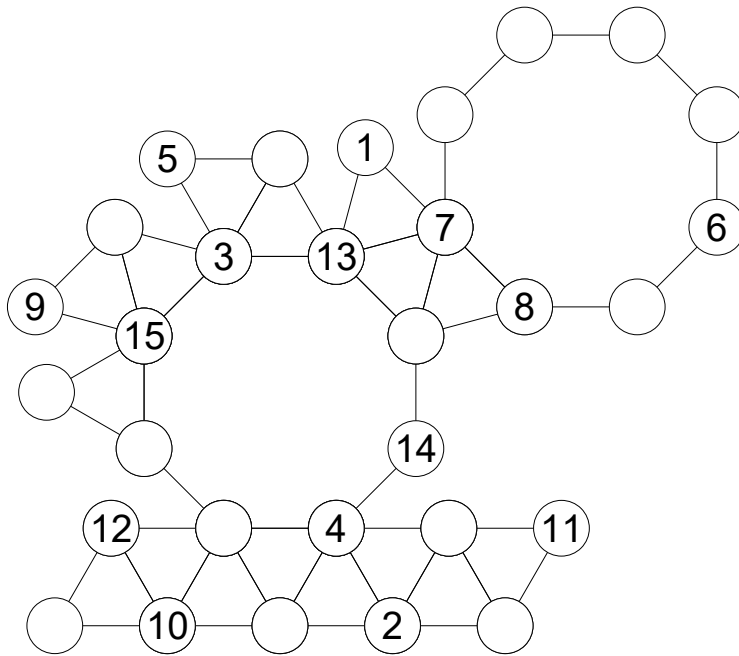

20

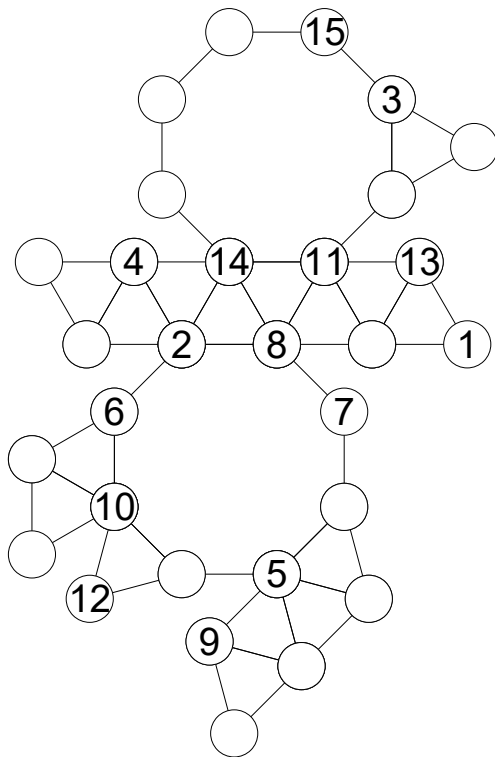

21

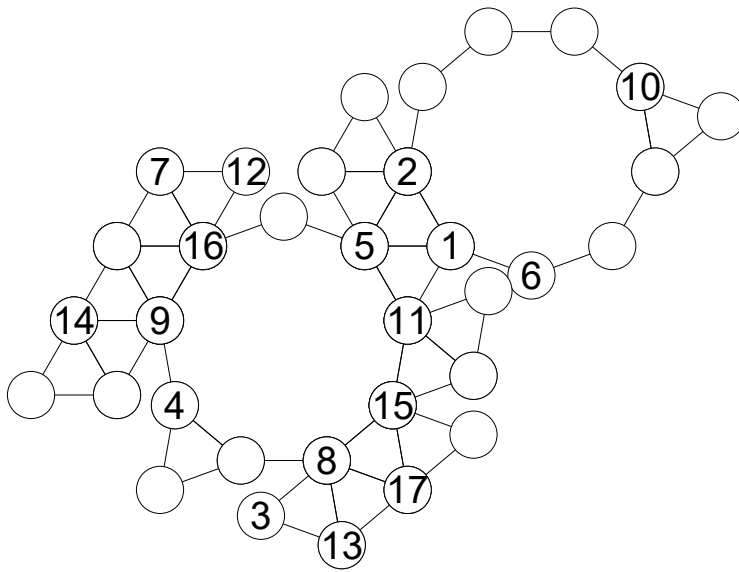

22

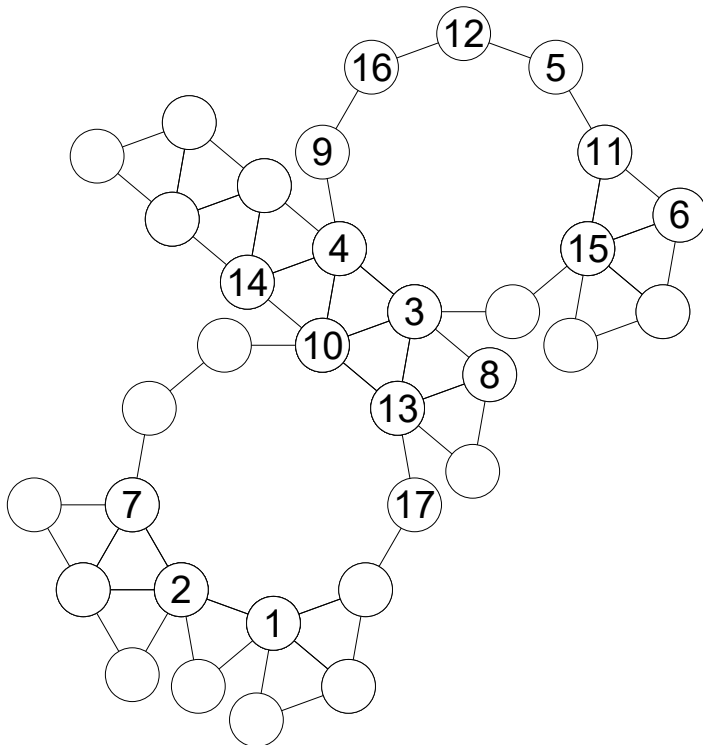

23

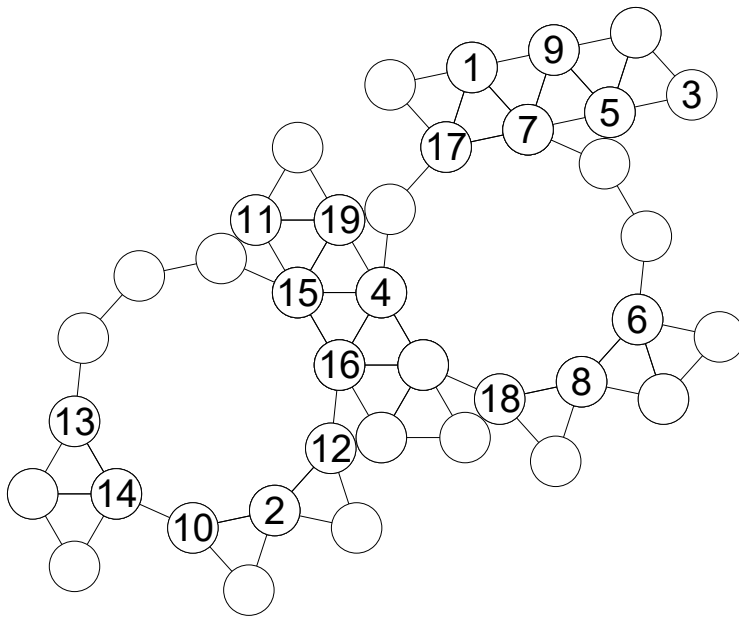

24

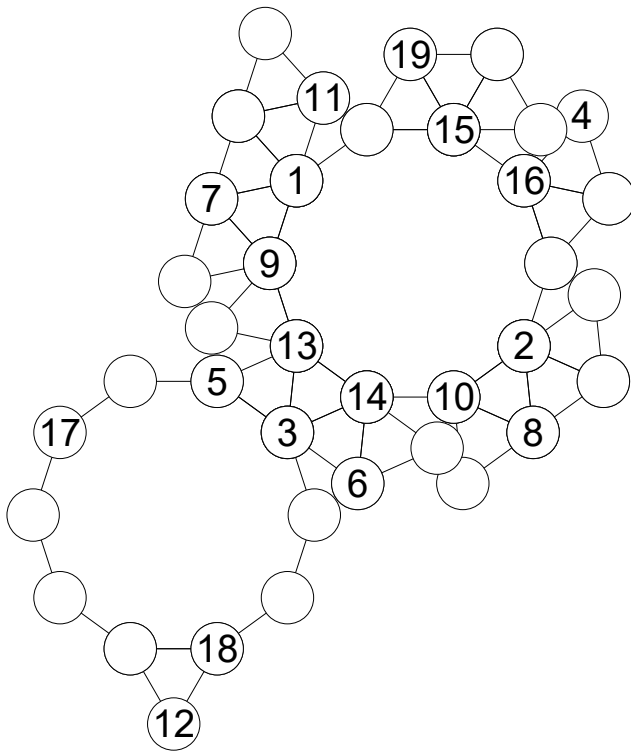

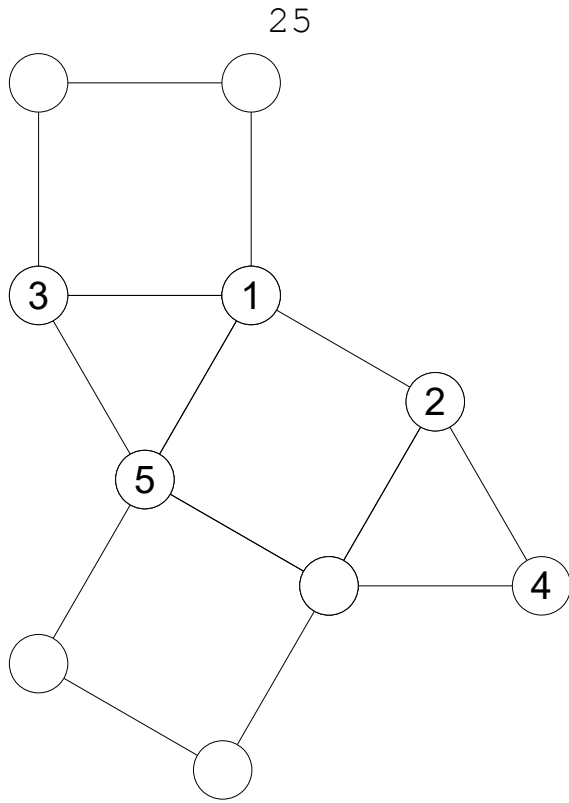

26

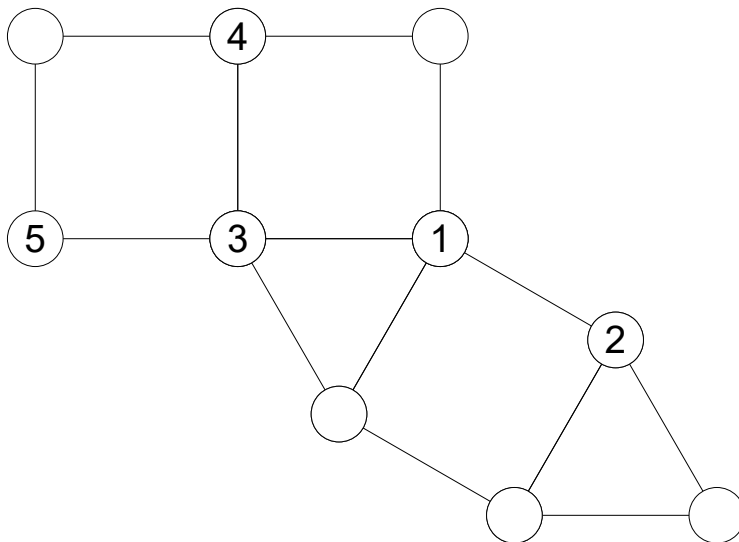

27

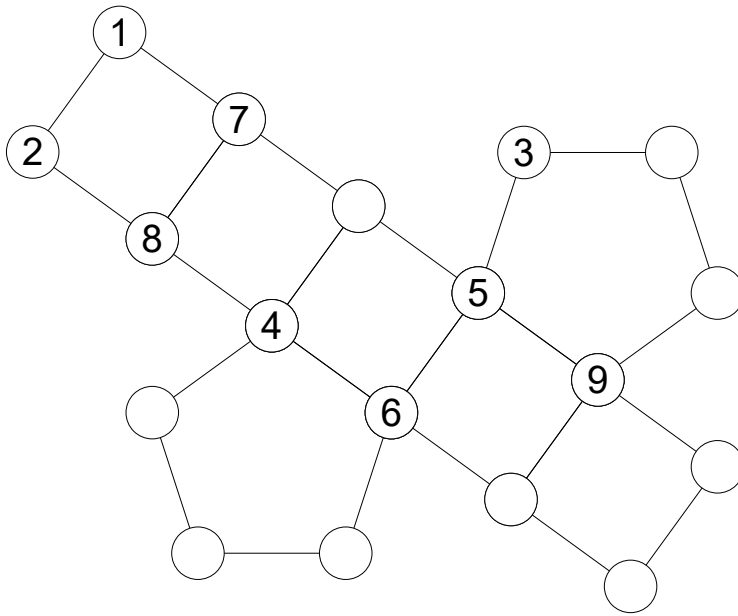

28

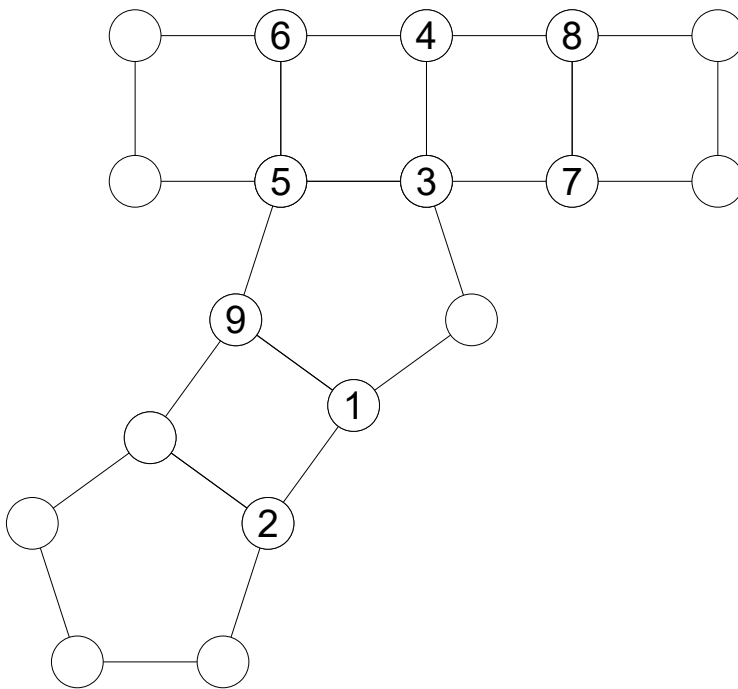

29

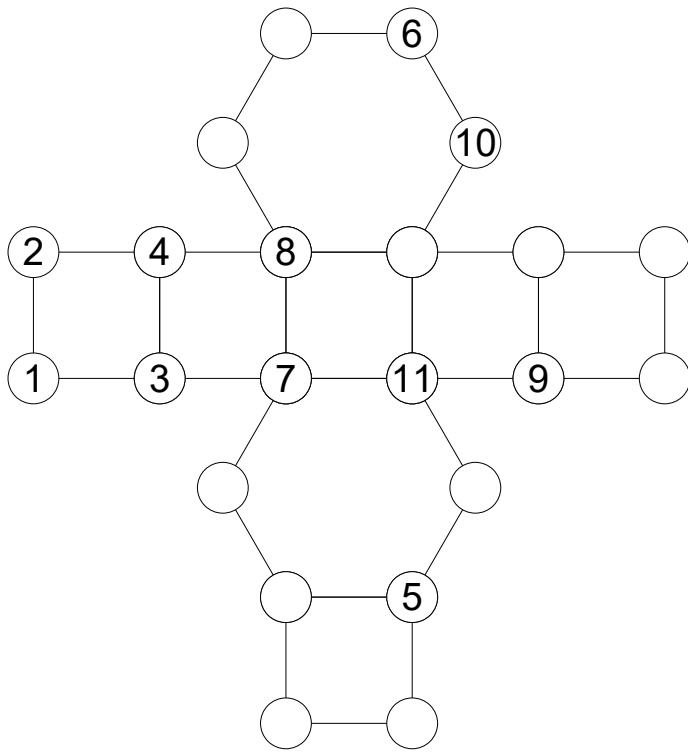

30

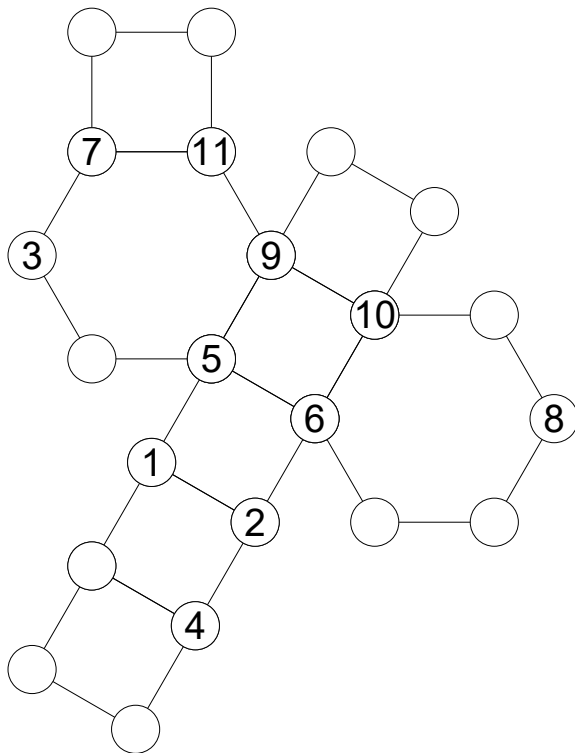

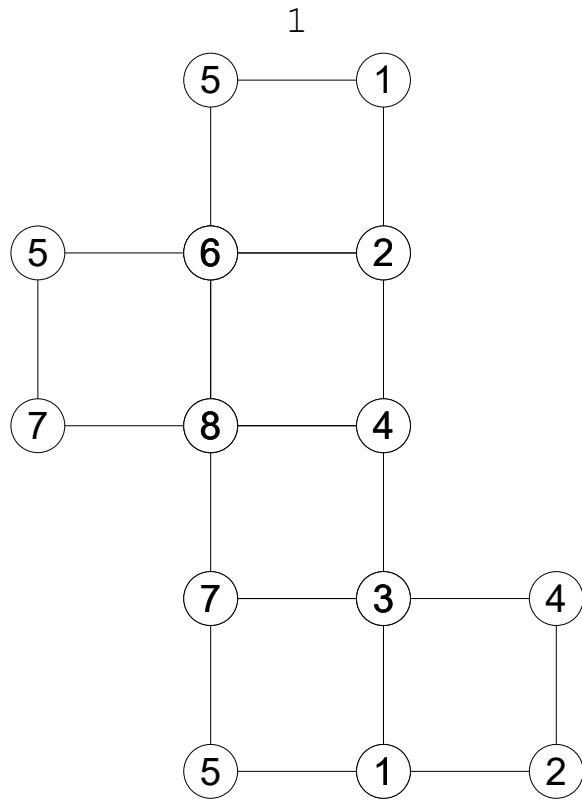

2

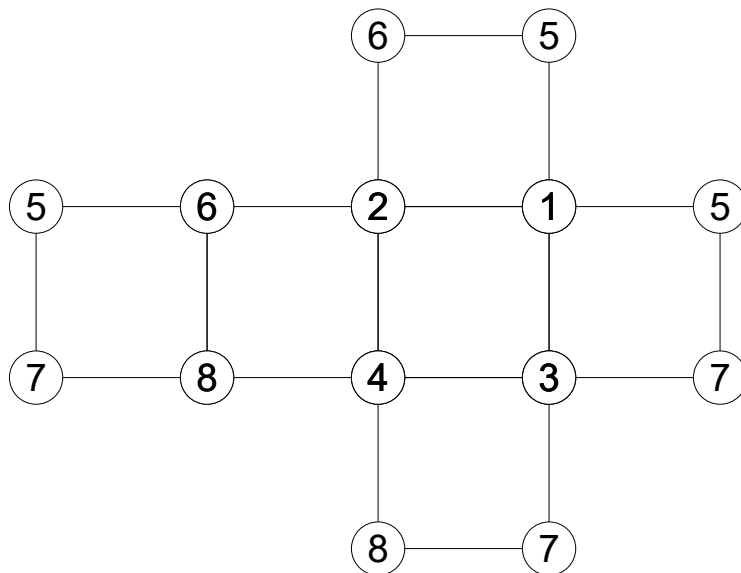

3

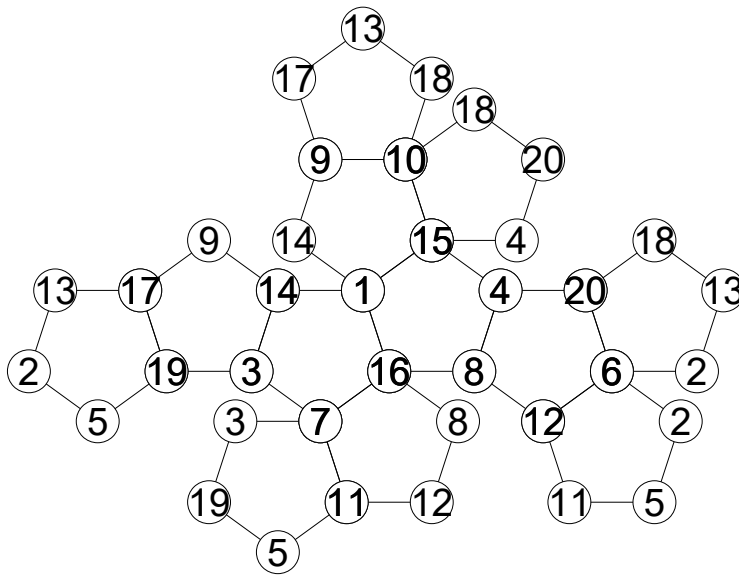

4

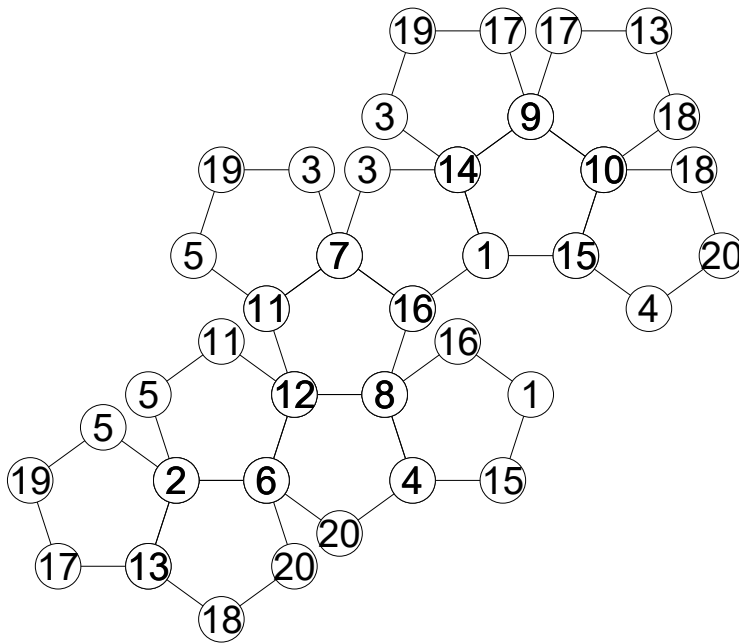

5

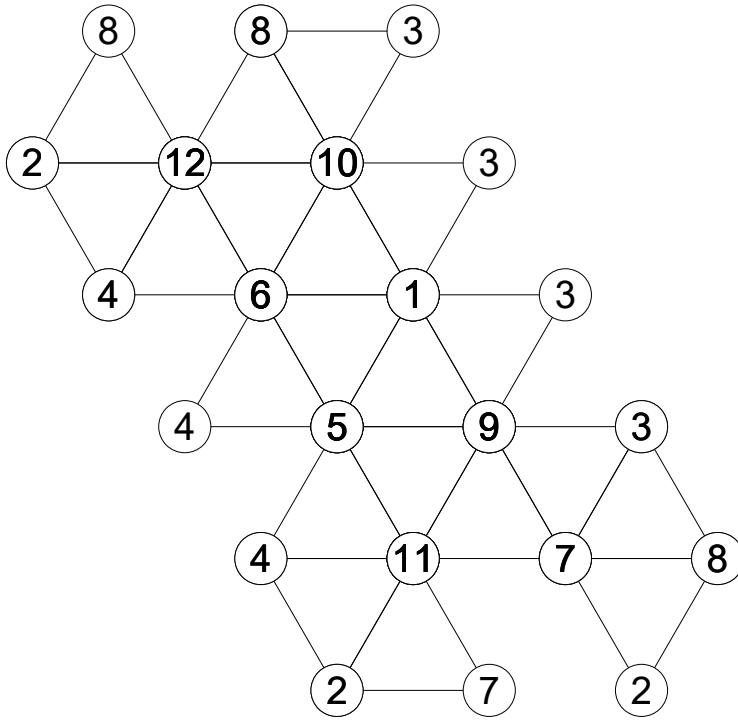

6

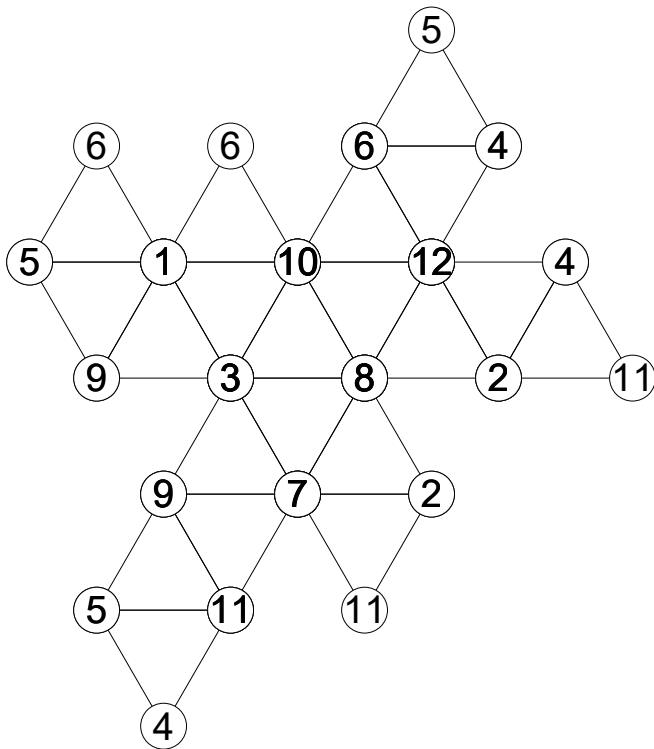

7

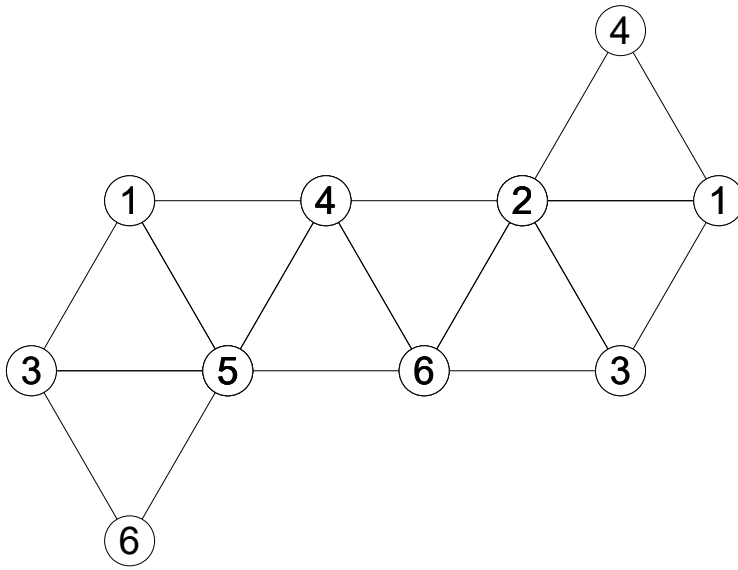

8

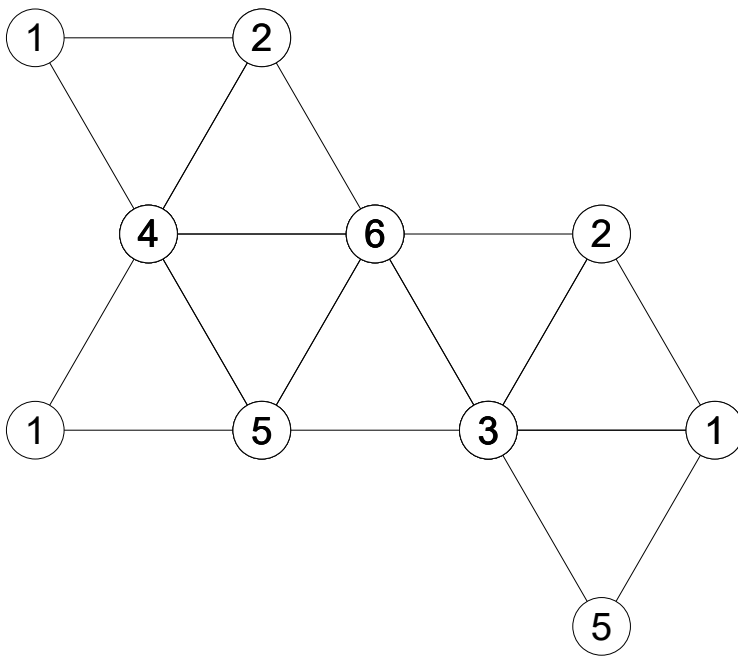

9

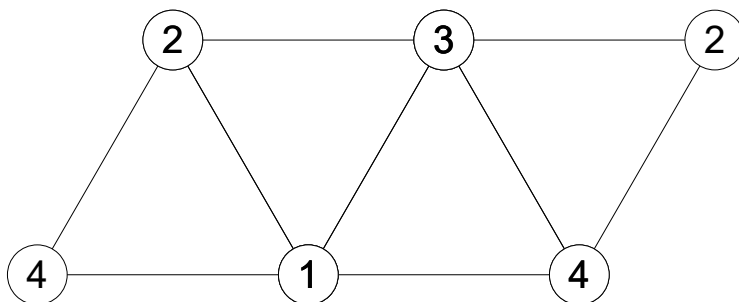

10

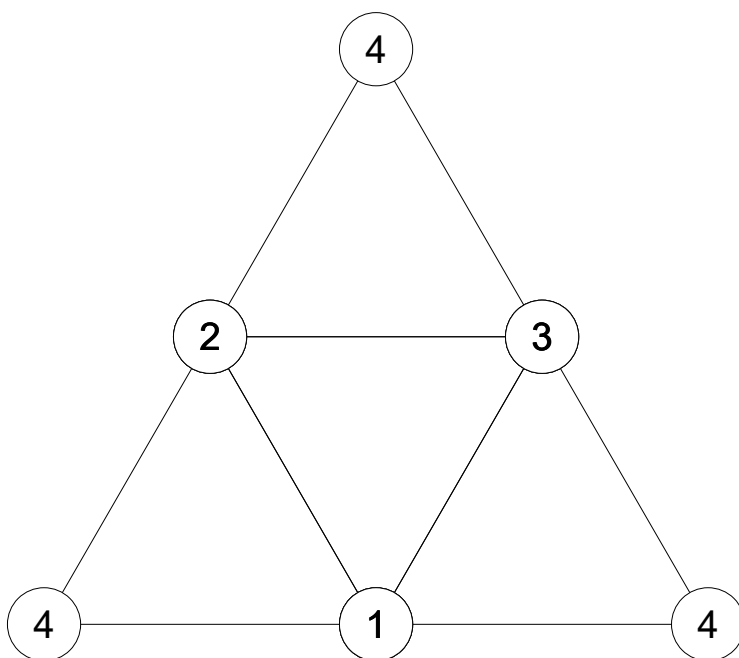

11

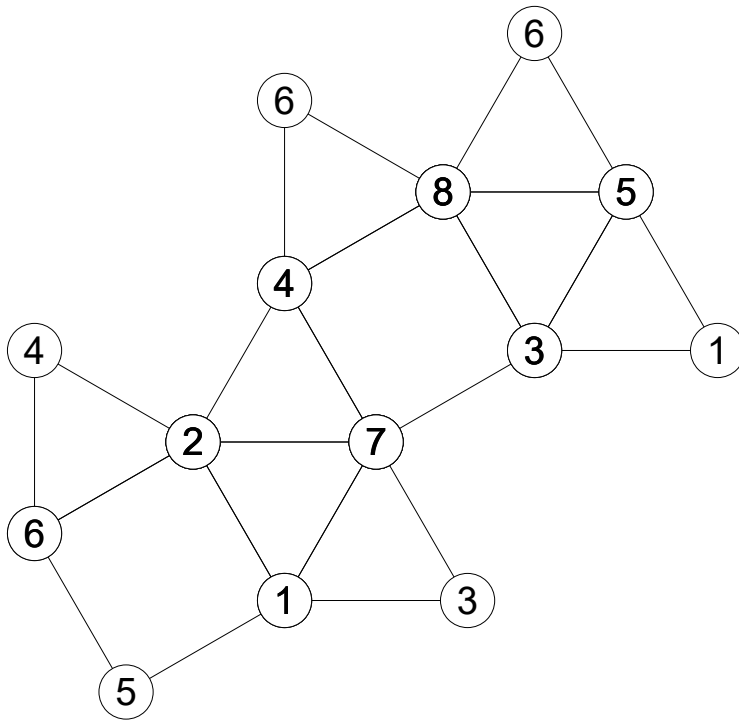

12

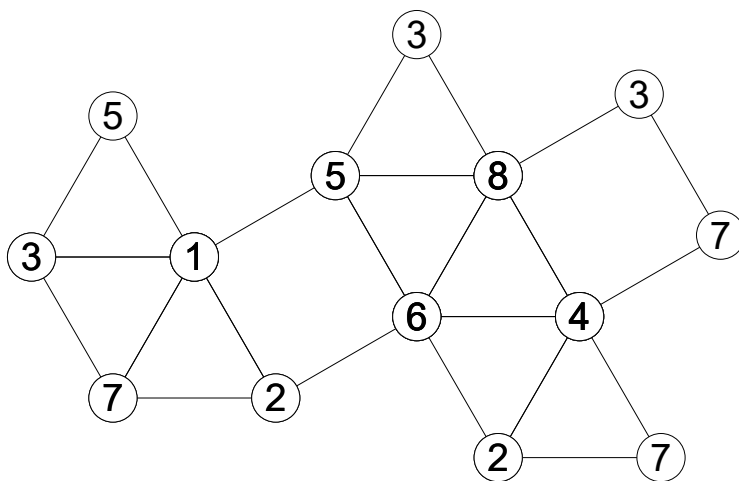

13

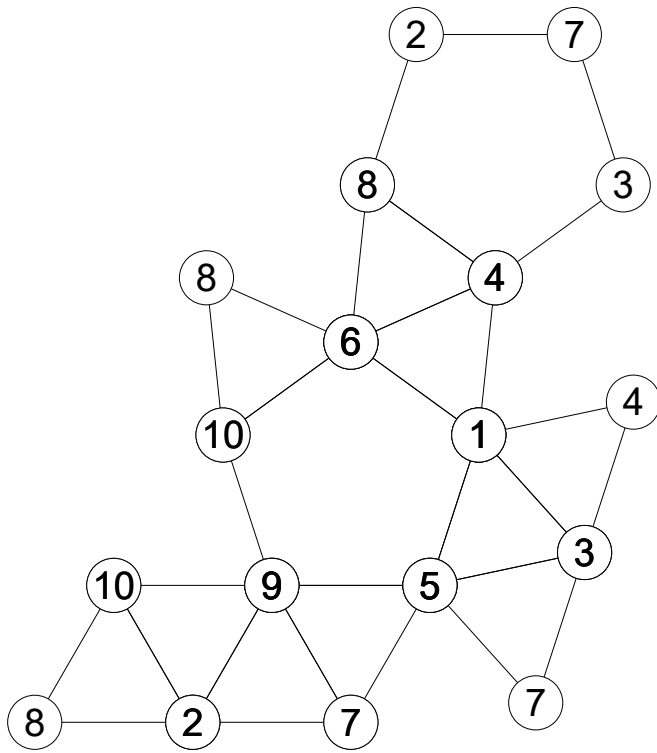

14

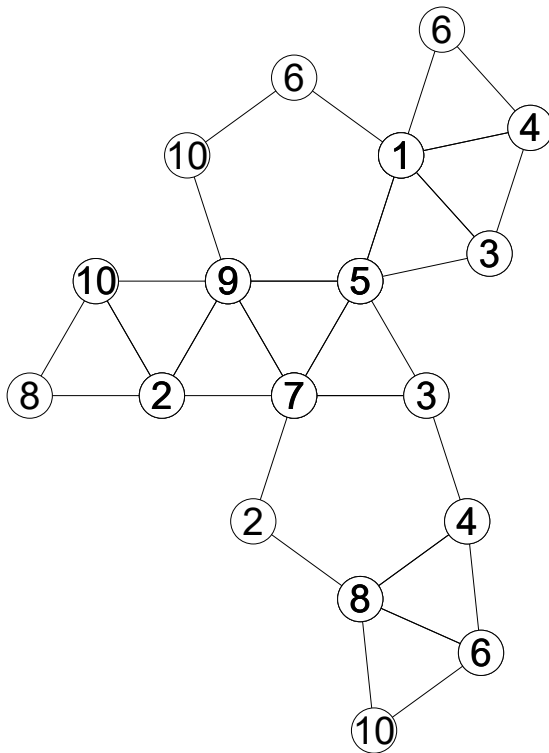

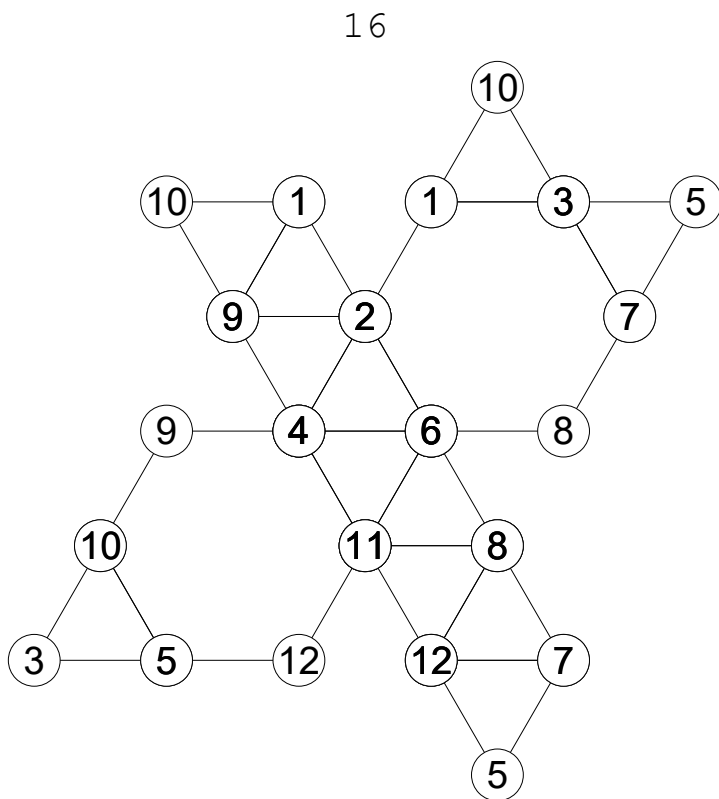
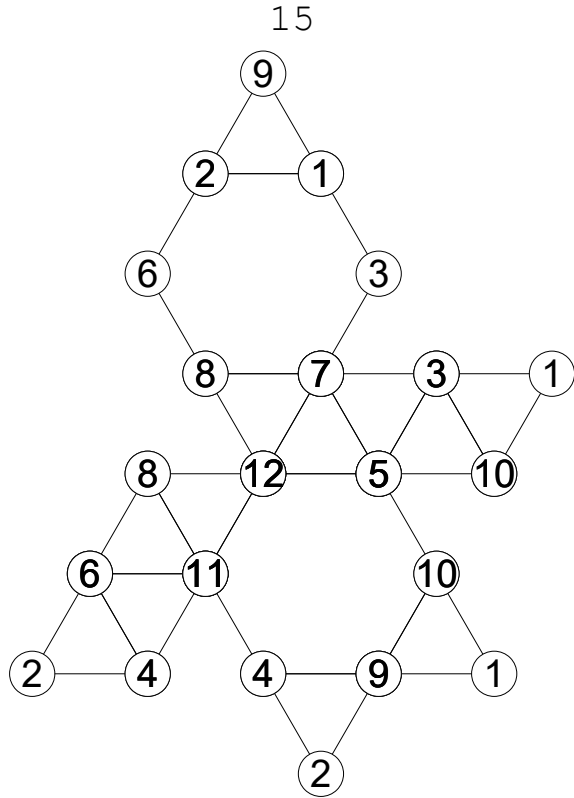

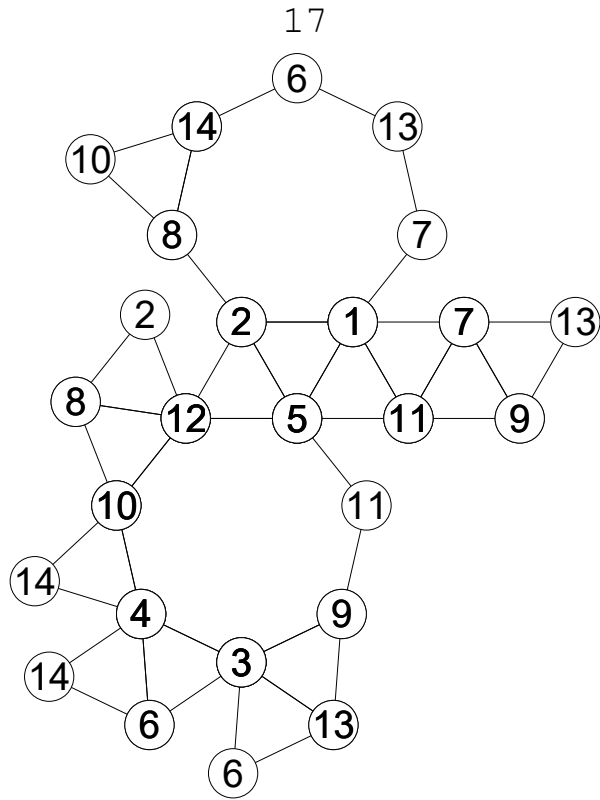

18

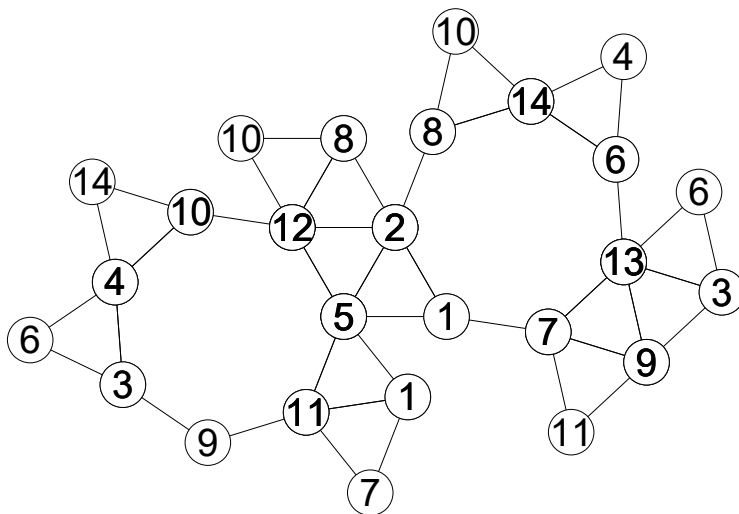

19

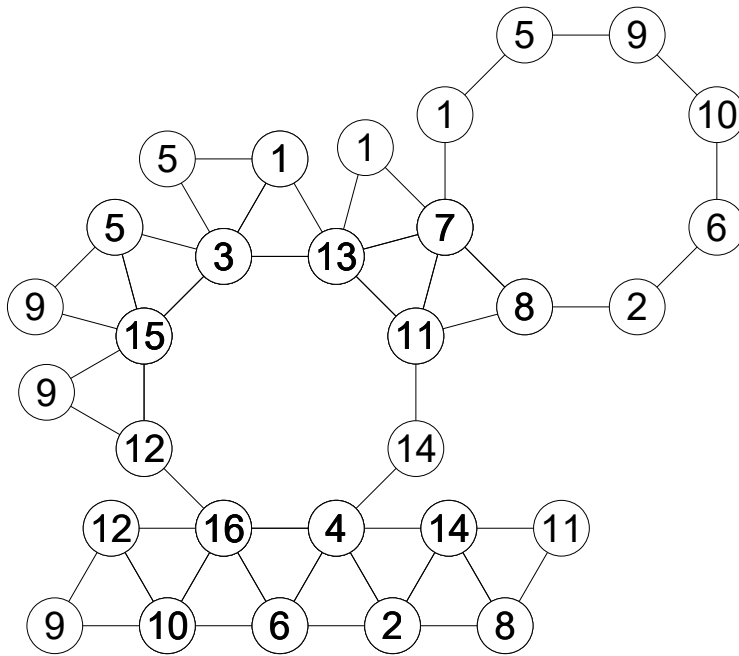

20

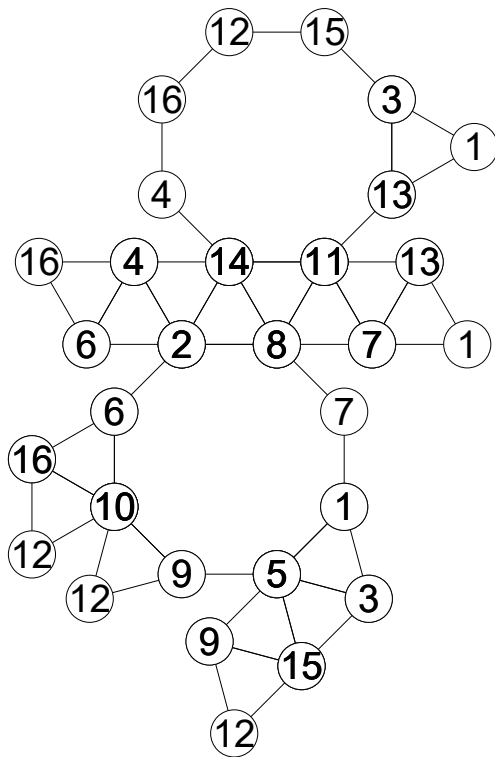

21

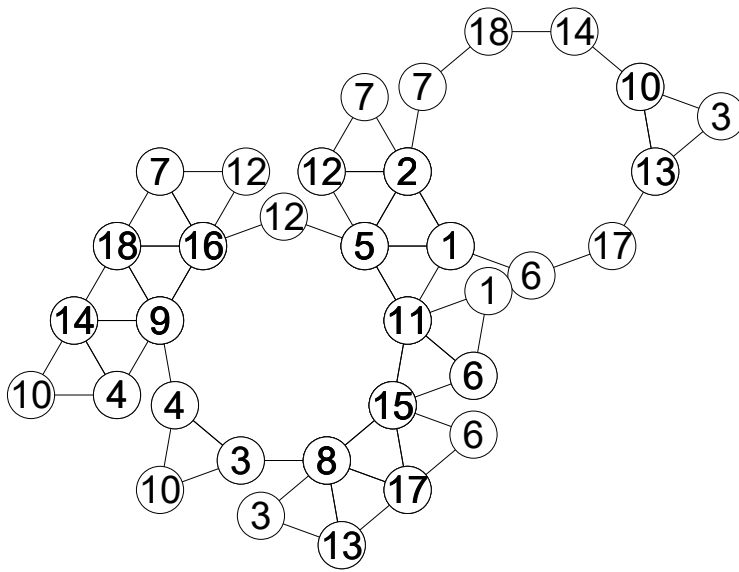

22

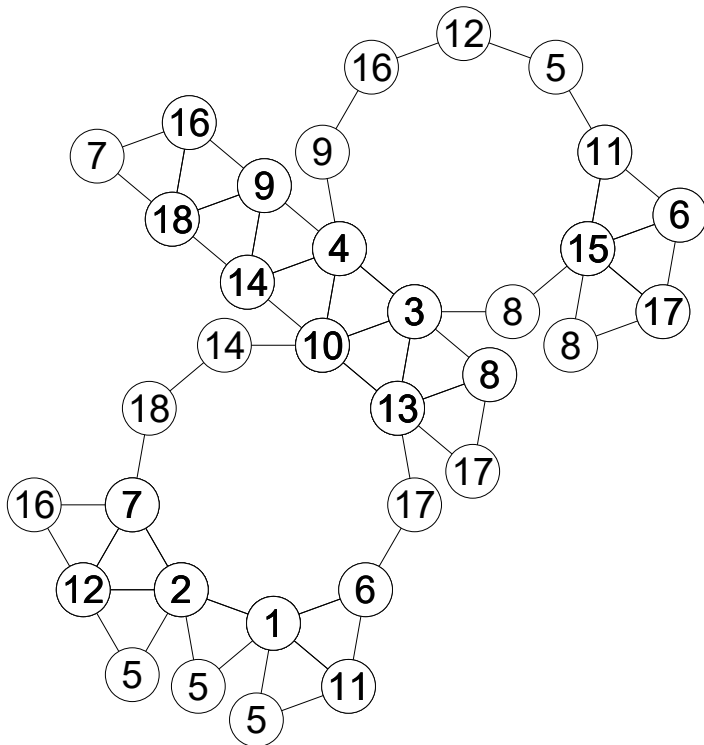

23

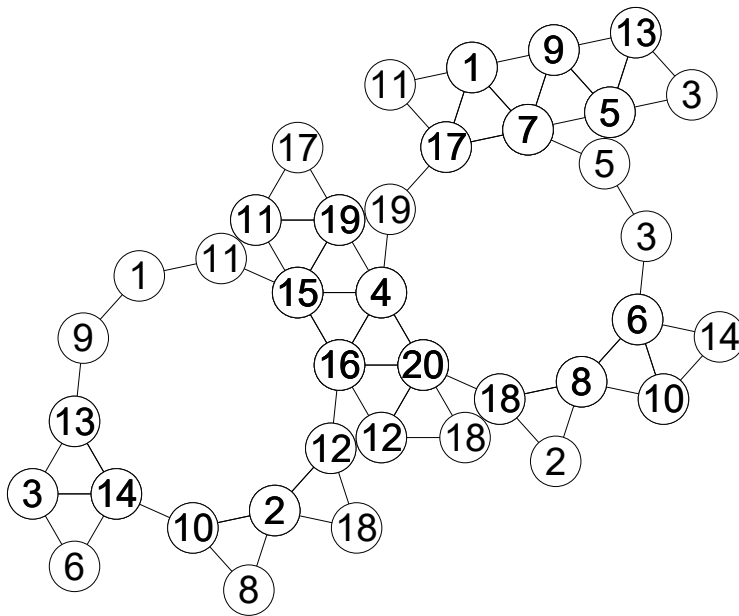

24

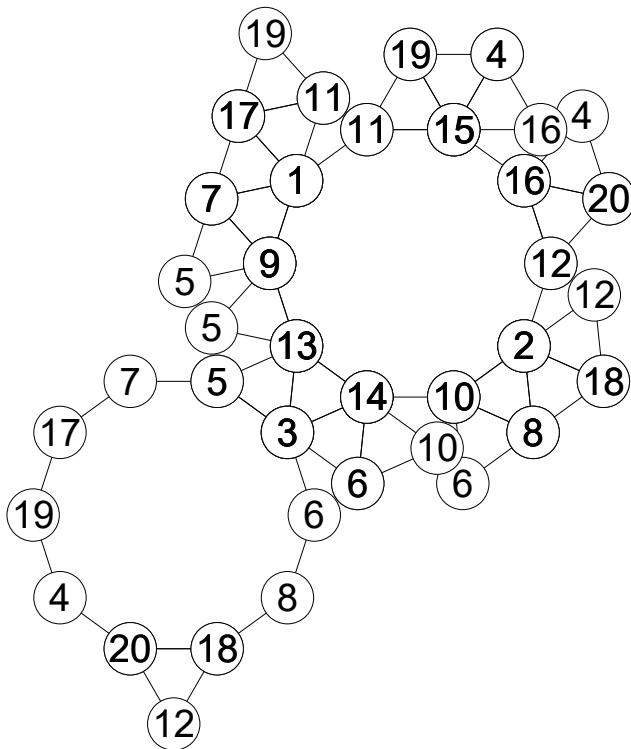

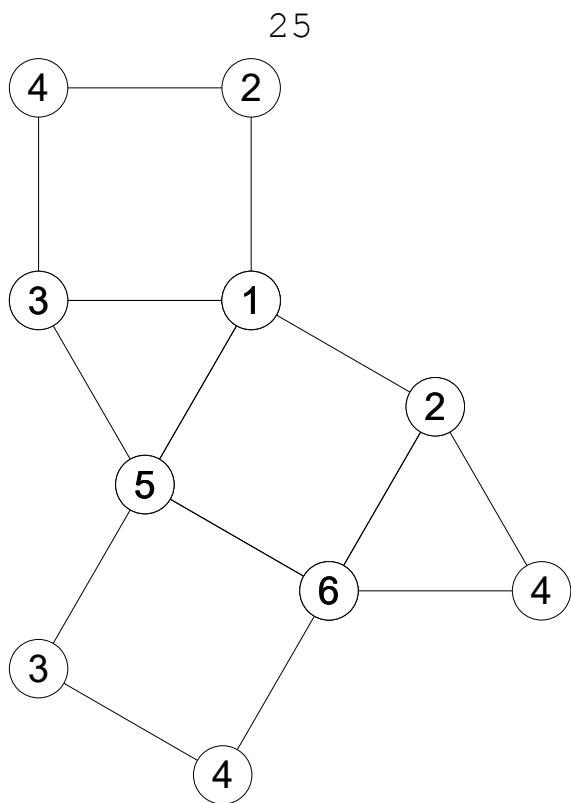

26

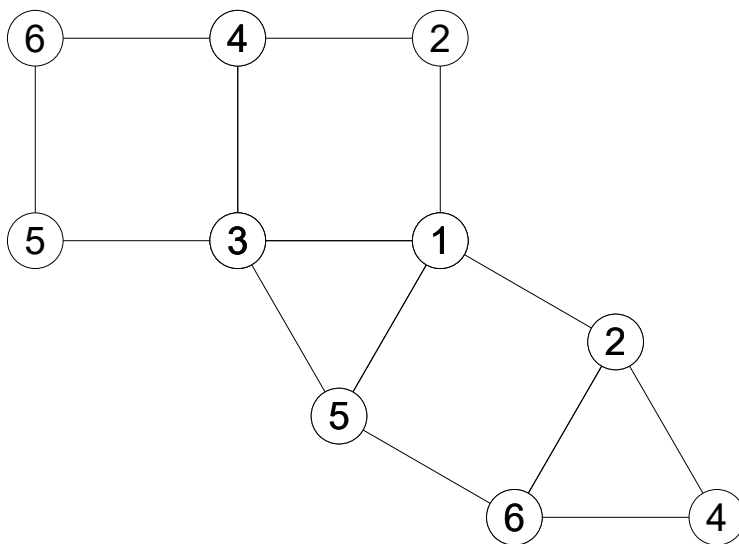

27

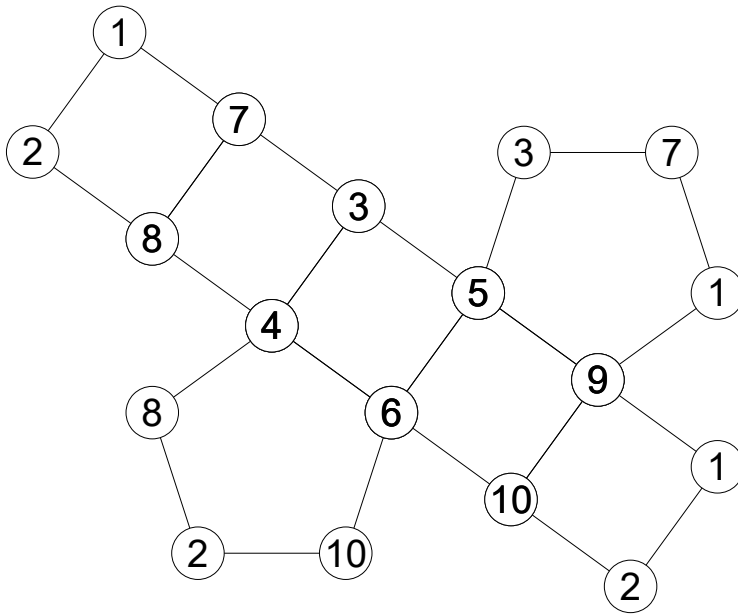

28

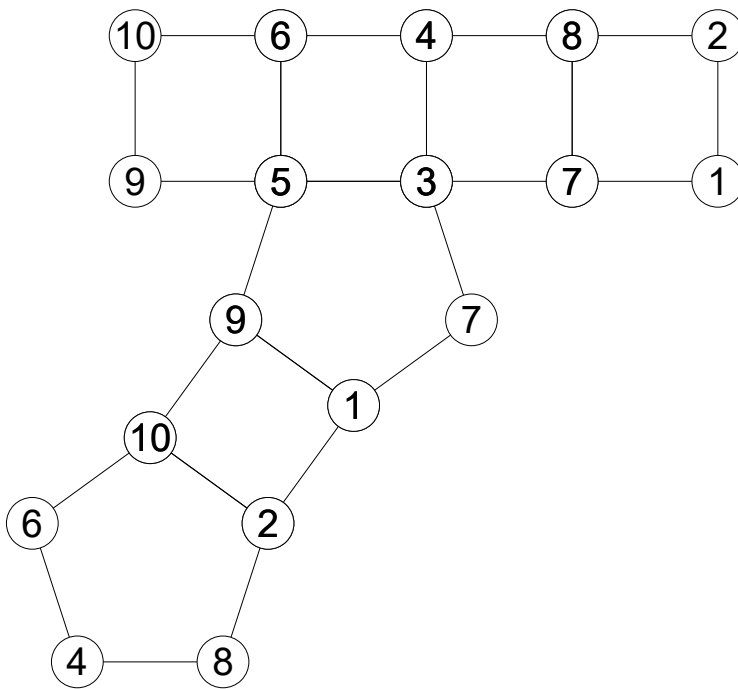

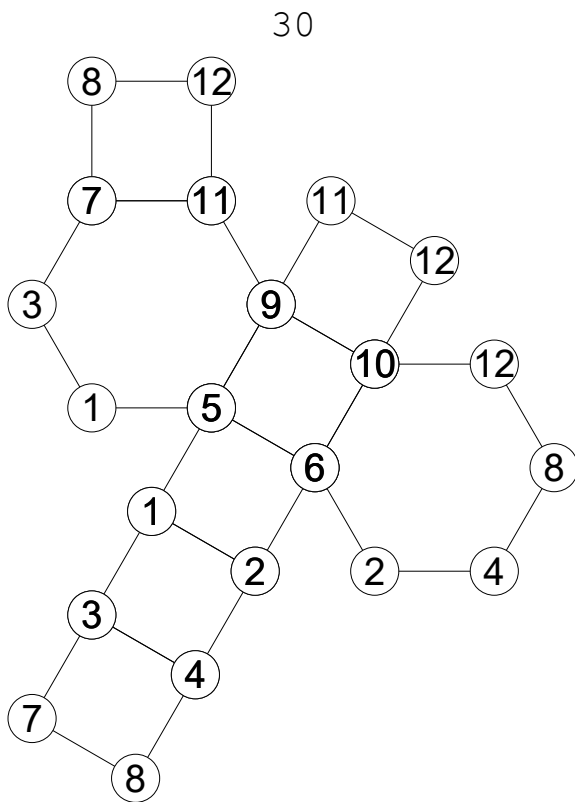
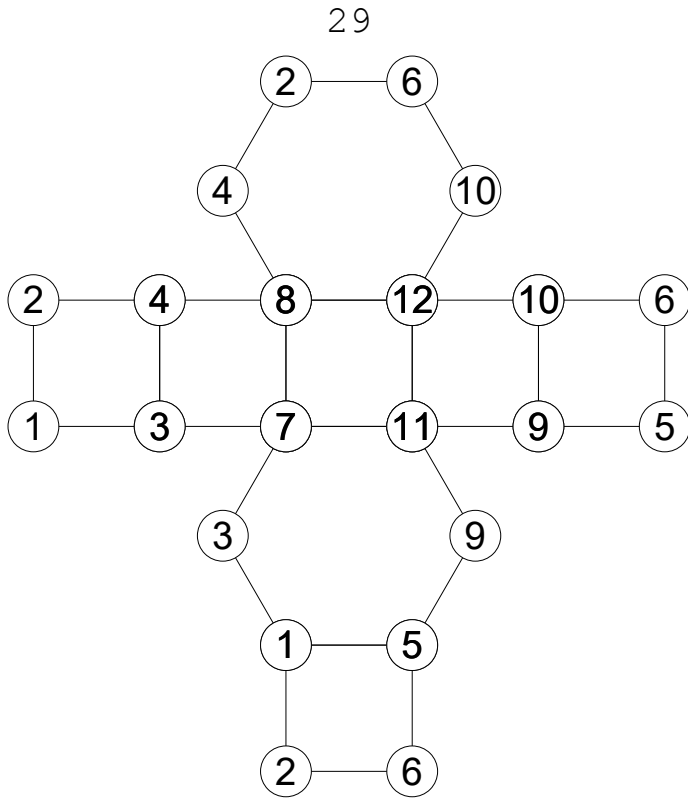

Izidor Hafner

"Mazes on the Edges of a Polyhedron"

<http://demonstrations.wolfram.com/MazesOnTheEdgesOfAPolyhedron/> Wolfram

Demonstrations Project

Published : June 3,

2014