

prof. Matemko

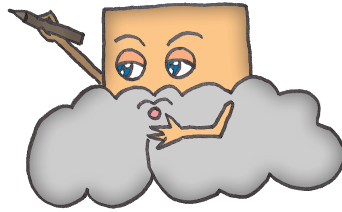

## Labirinti na robovih mnogoterca

Na telesu, ki je dano z mrežo, poišči najkrajšo pot od temnejše do svetlejše pike! Giblješ se lahko samo po odebeljenih črtah. Iz neke točke na mreži lahko preskočiš na drugo točko, če in samo če točki predstavljata isto oglišče telesa. Nekatera oglišča mreže so že označena z zaporednimi številkami. V vsak neoznačen krog vpiši številko tako, da bodo oglišča na mreži, ki predstavljajo isto oglišče telesa, označena z isto številko. Pot zapiši kot zaporedje številk od temnejše do svetlejše pike.

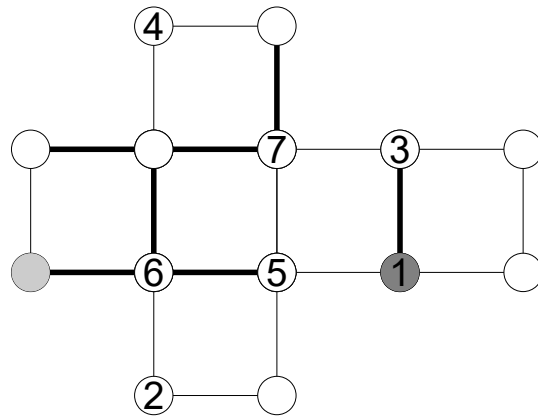

**MATHEMA**

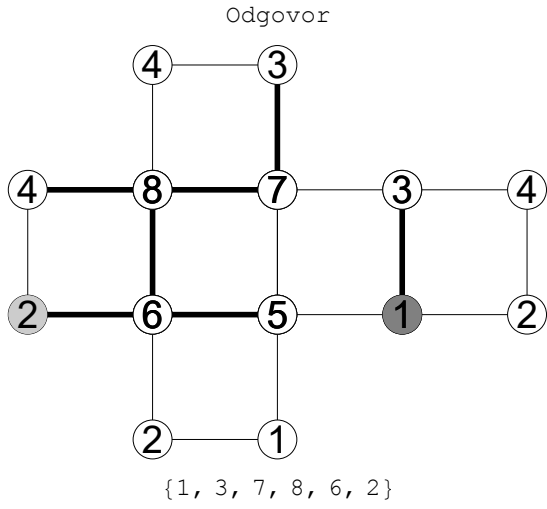

# Naloge

1

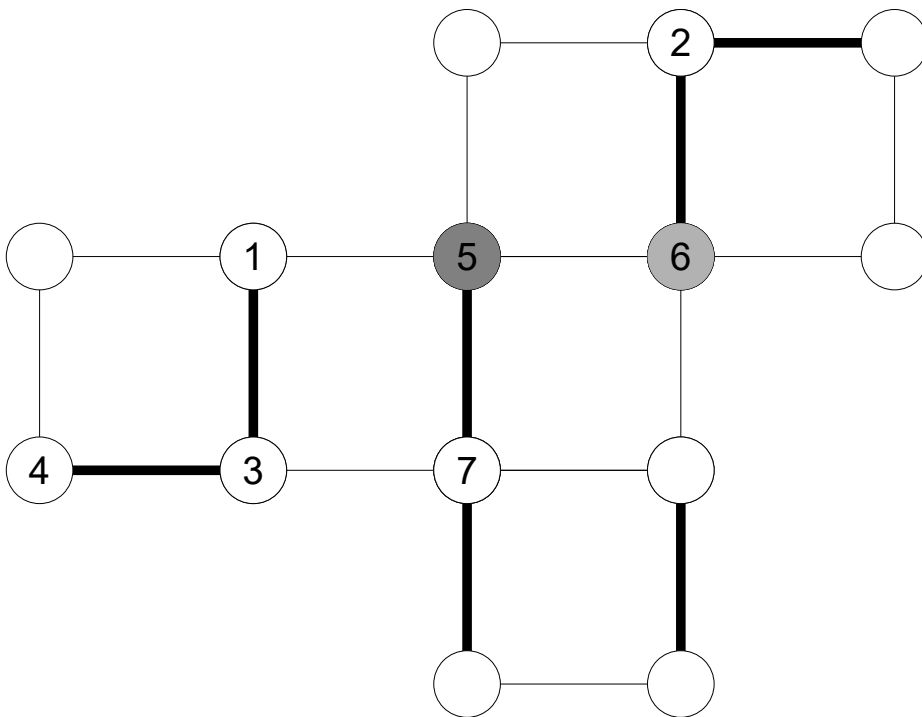

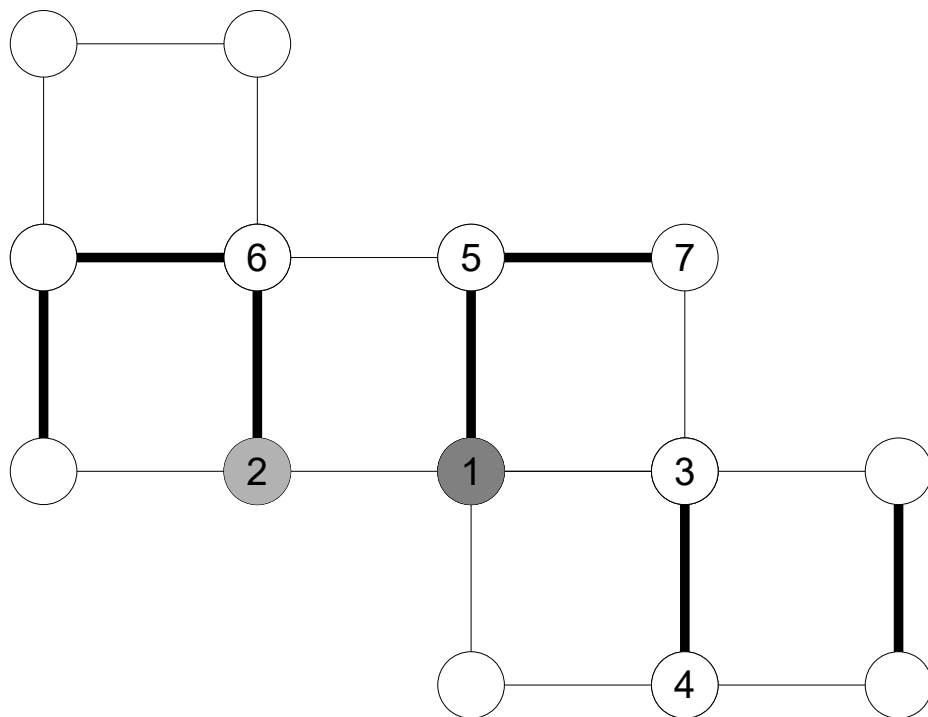

3

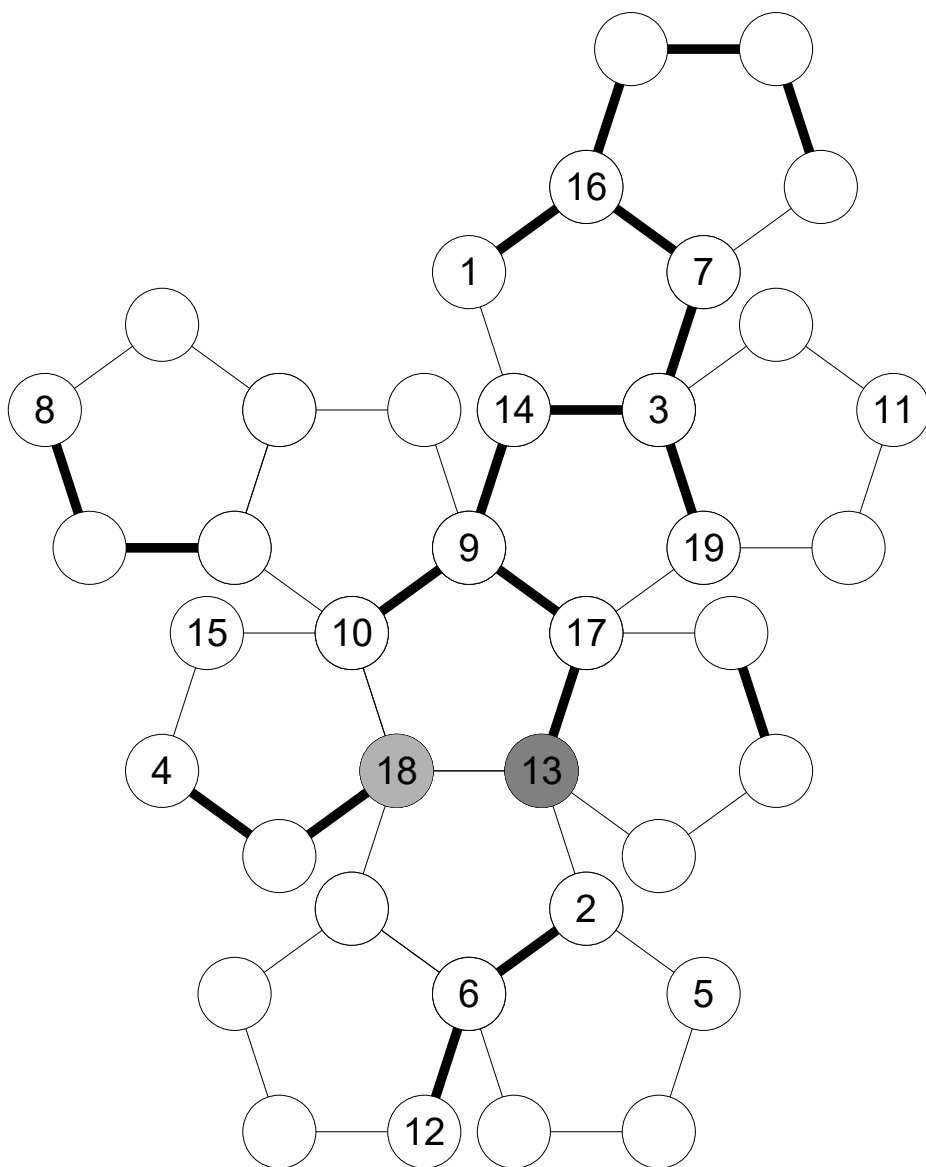

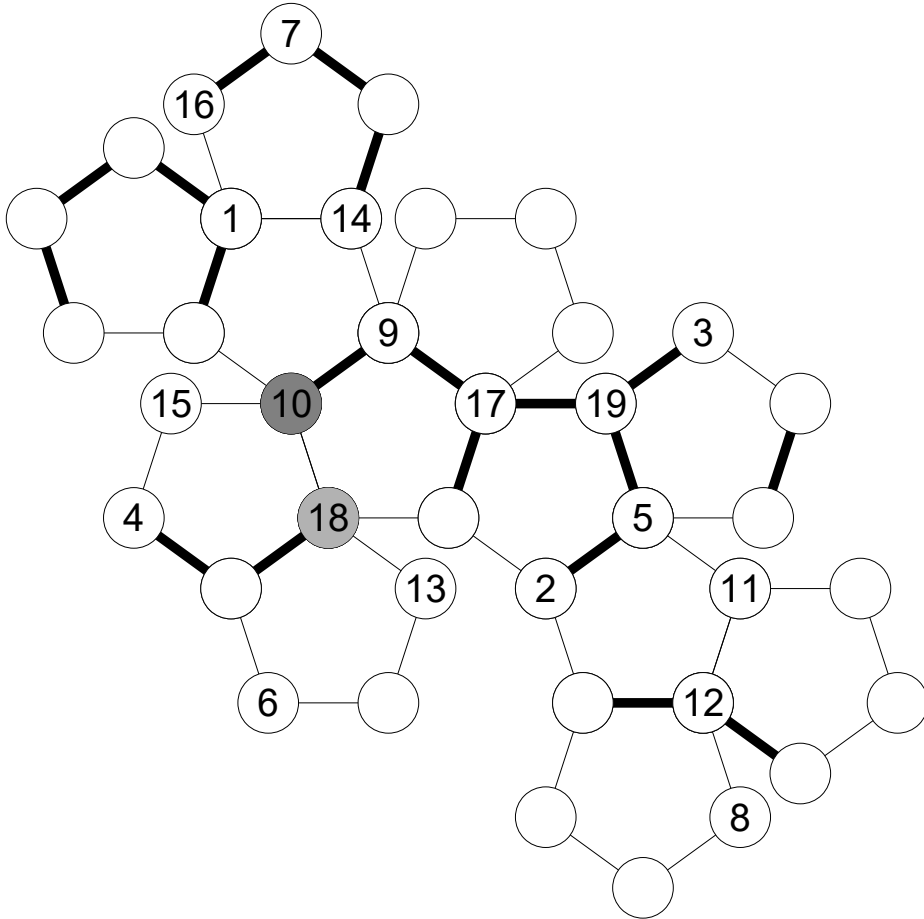

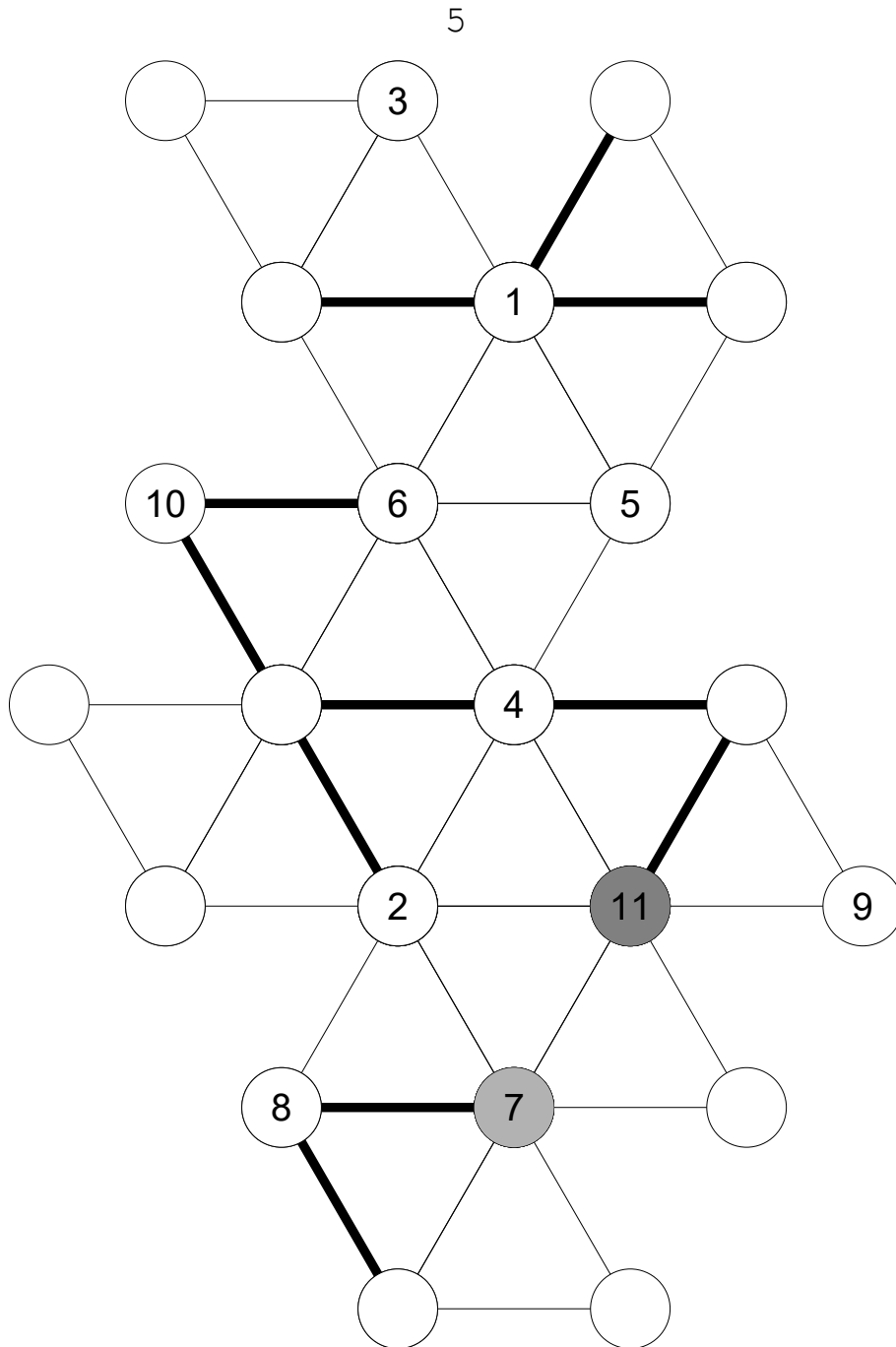

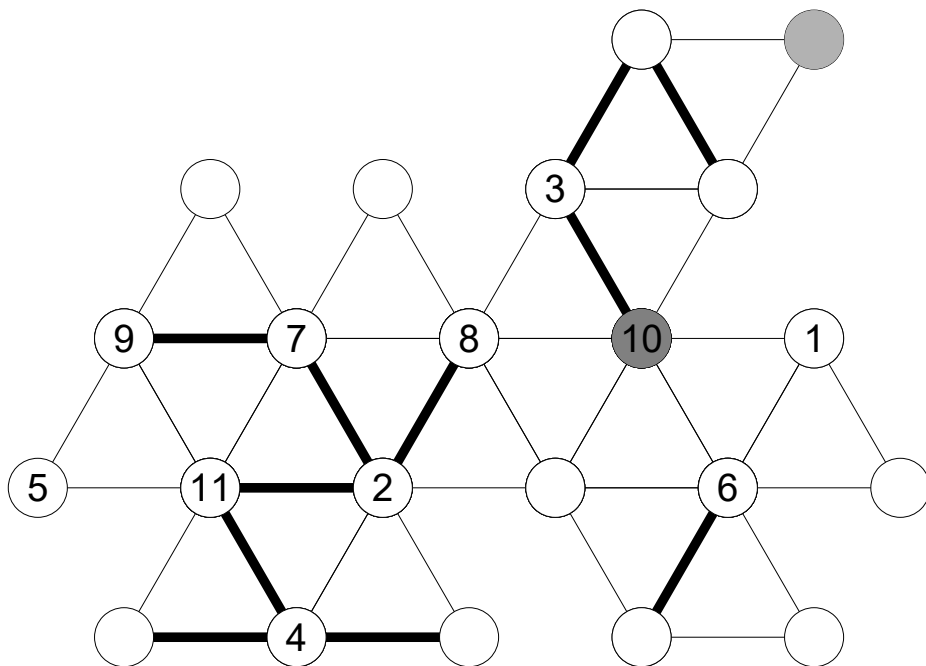



7

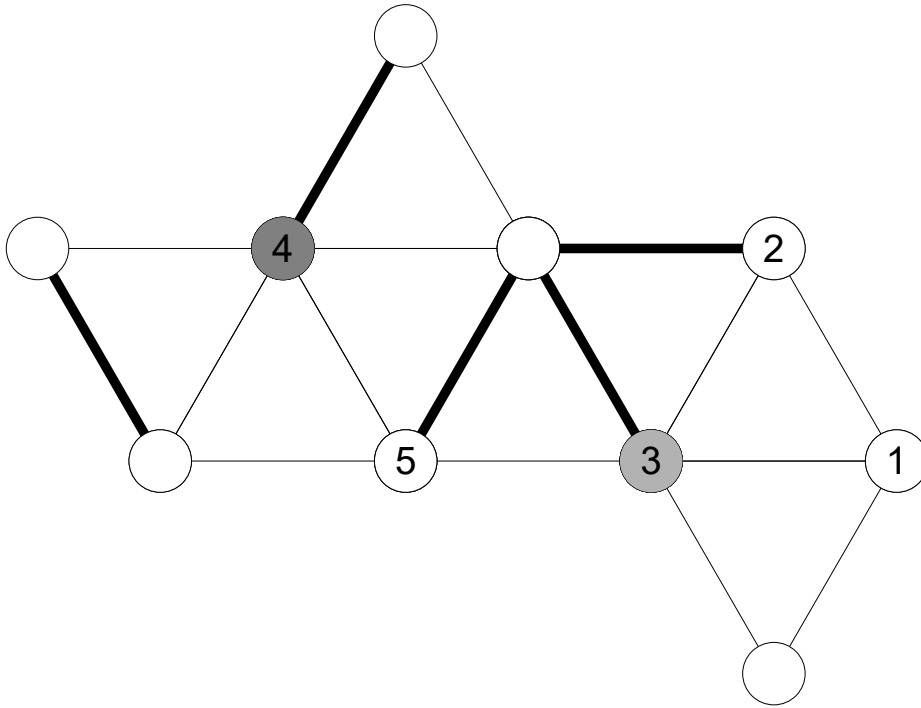

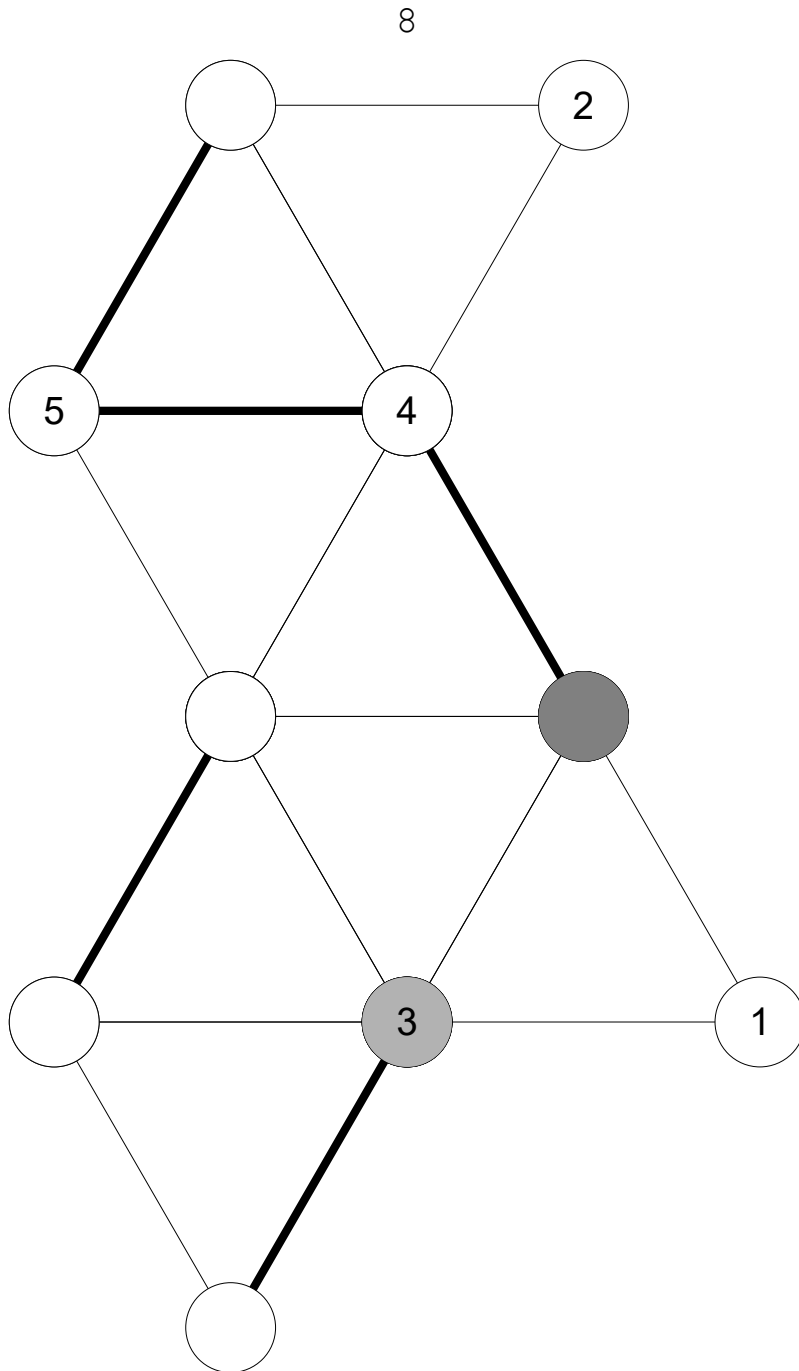

9

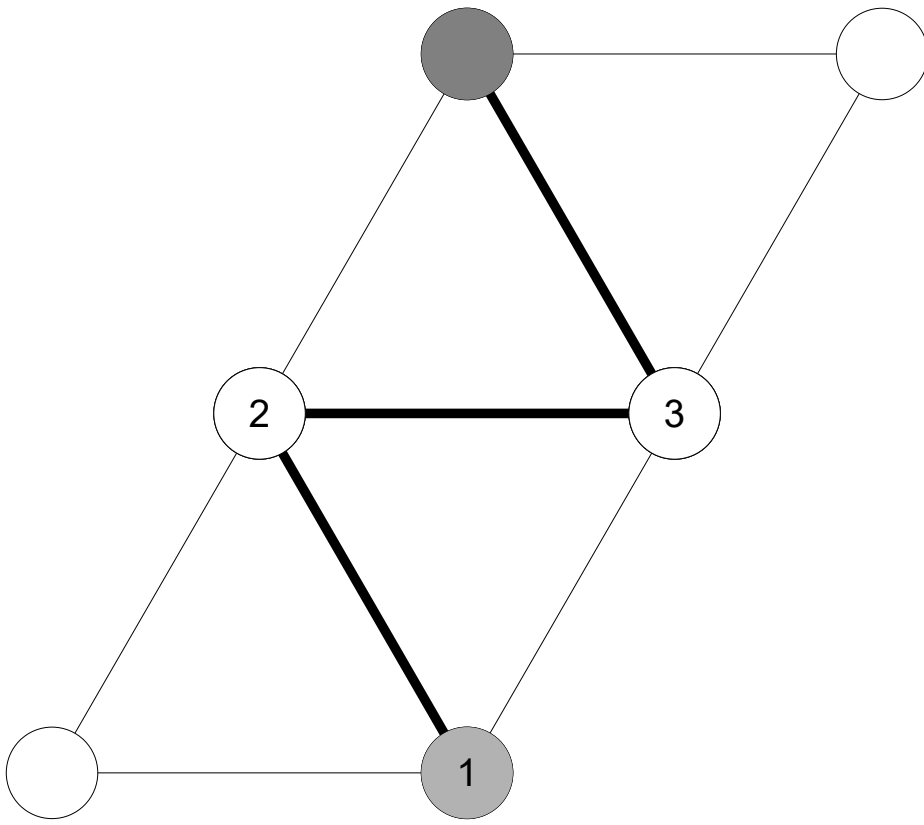

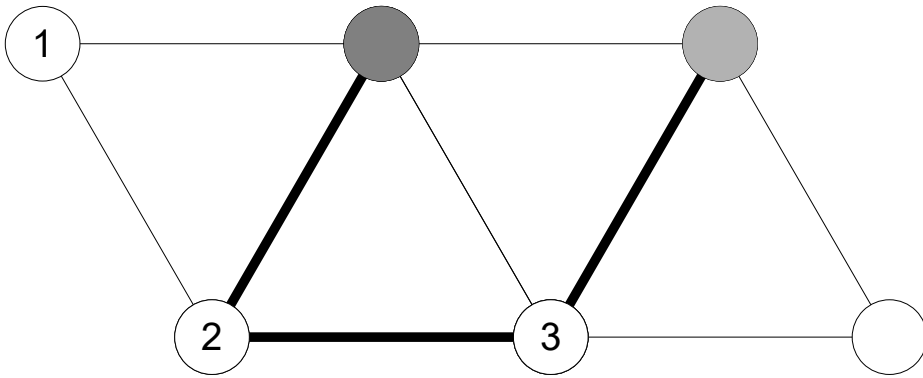

11

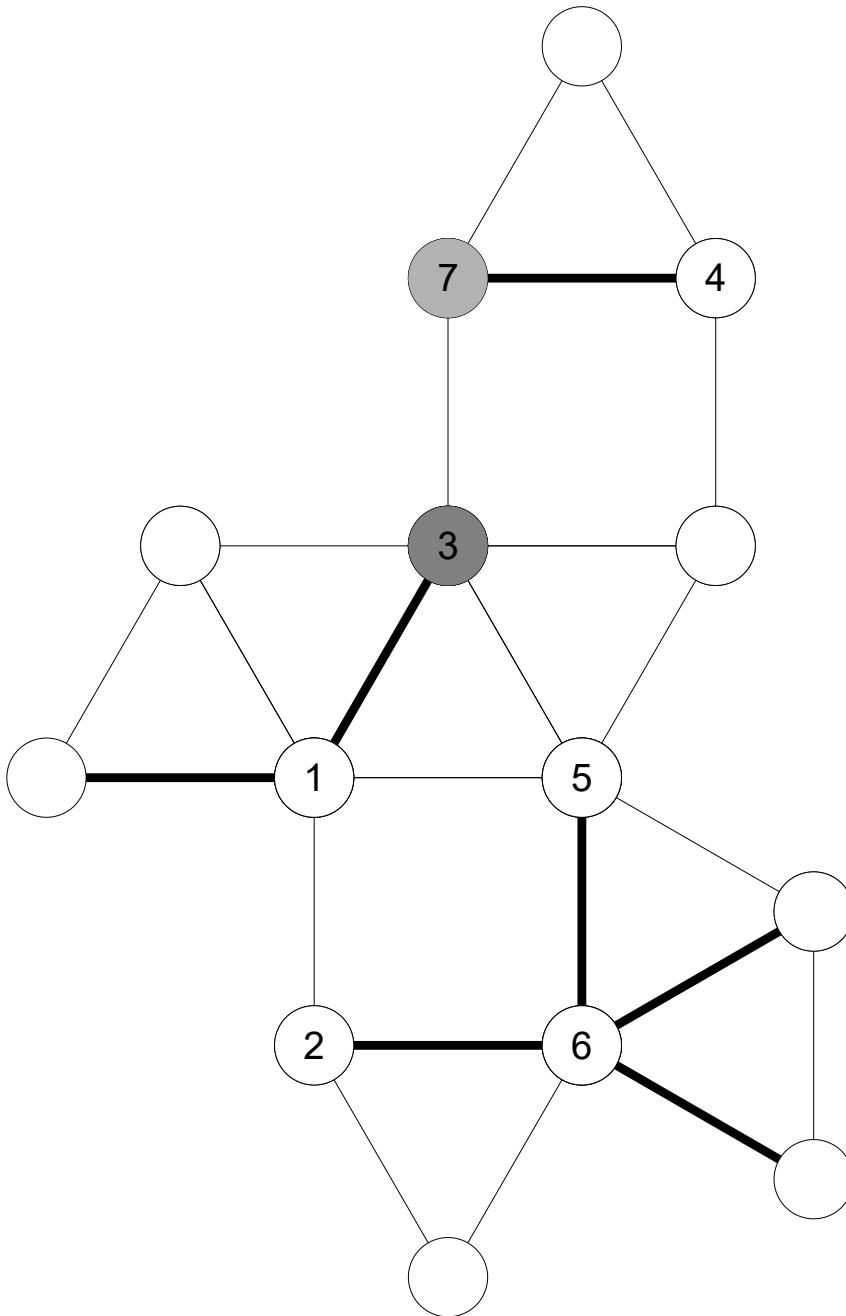

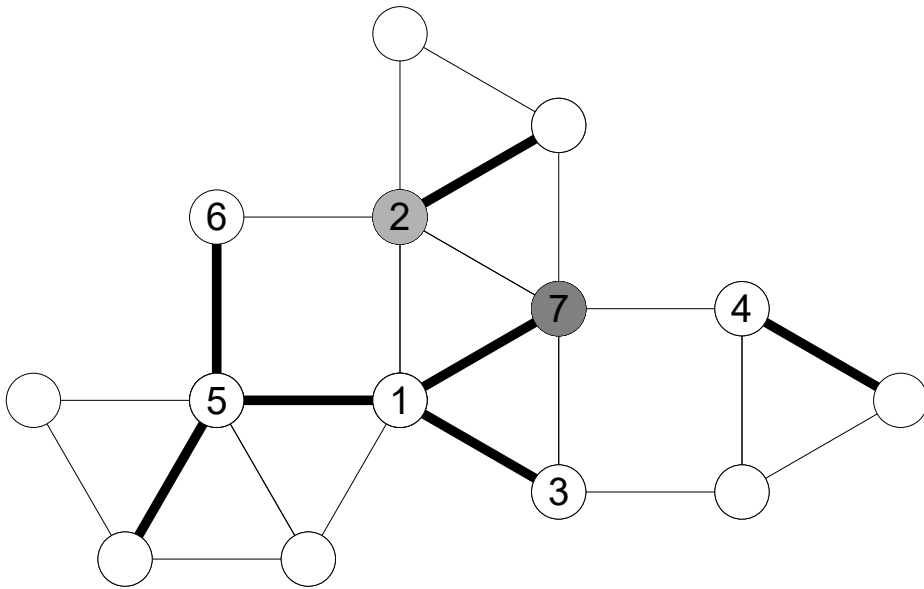

13

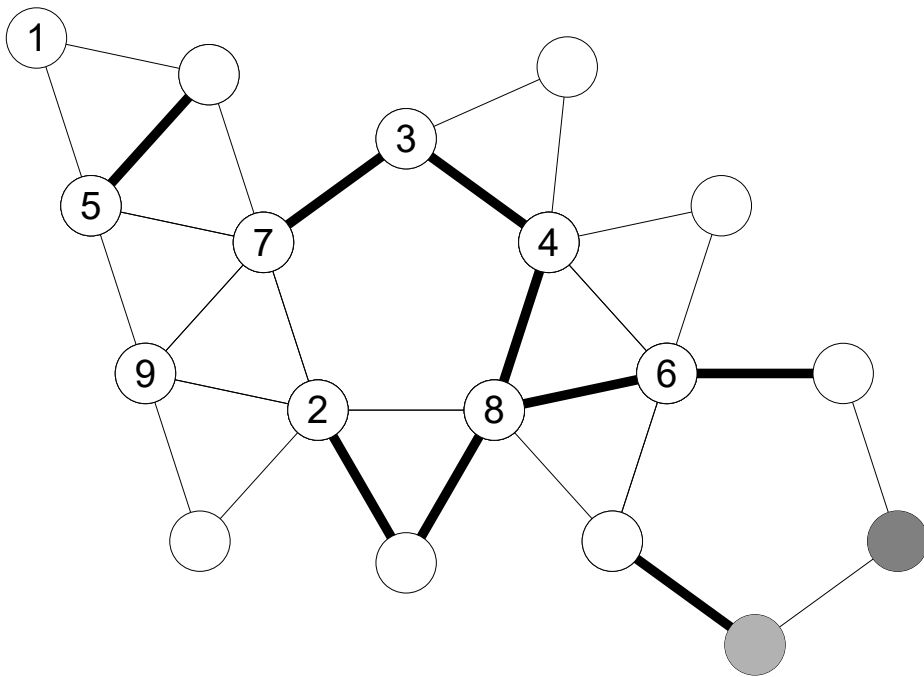

14

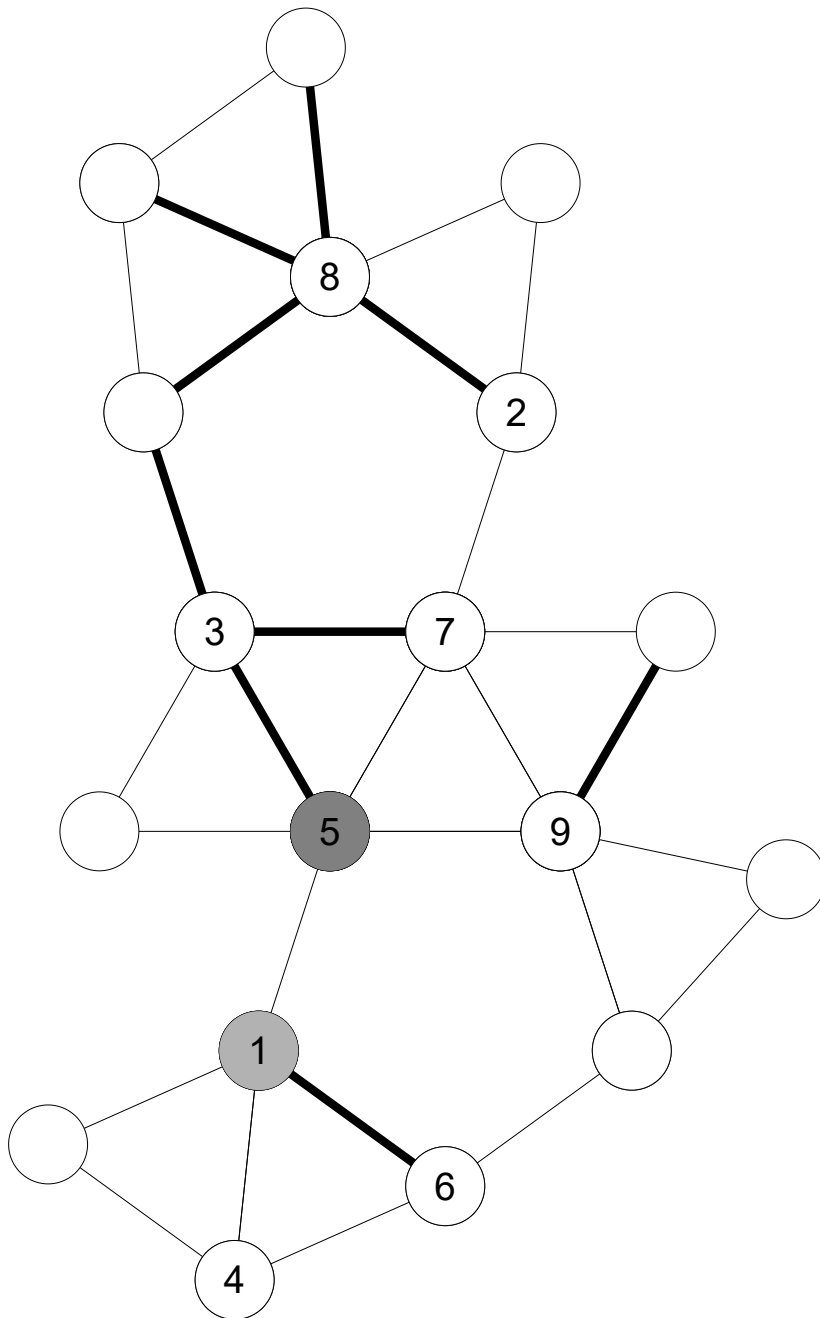



15

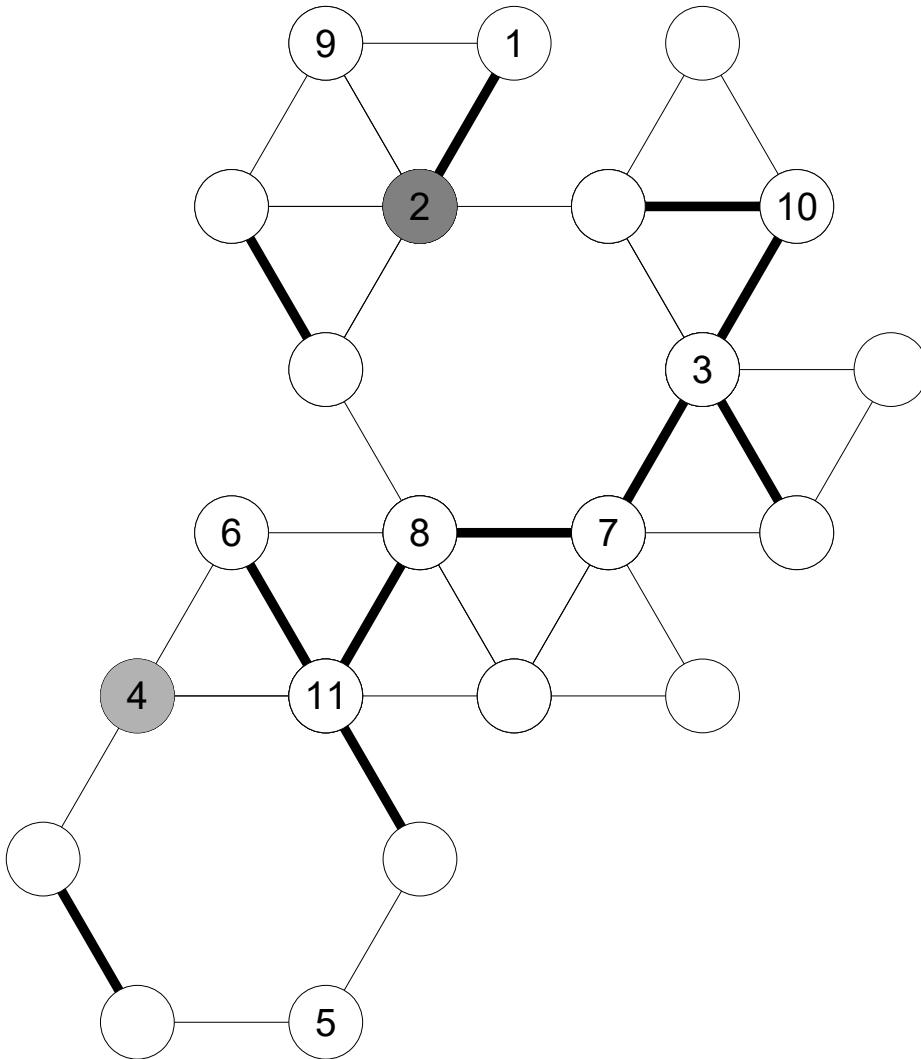

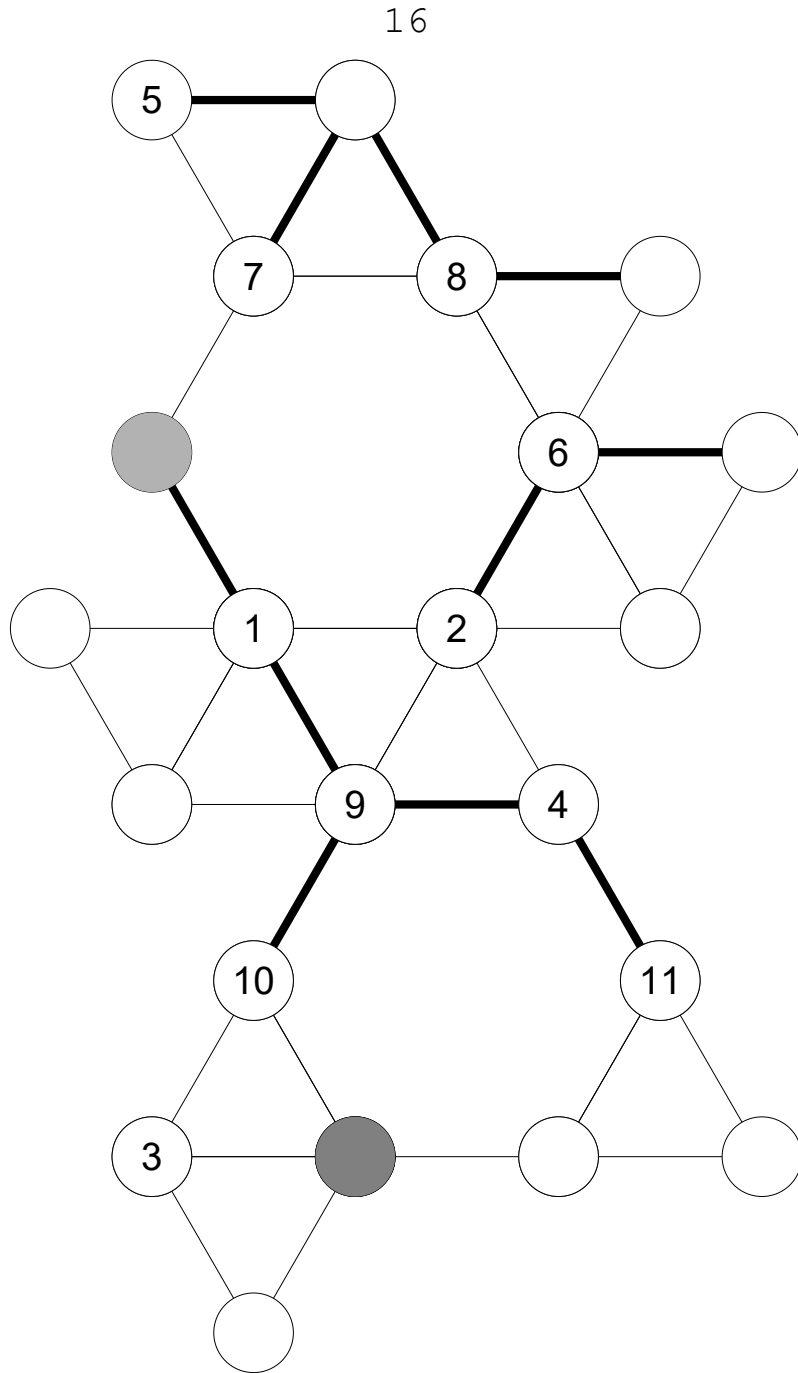

17

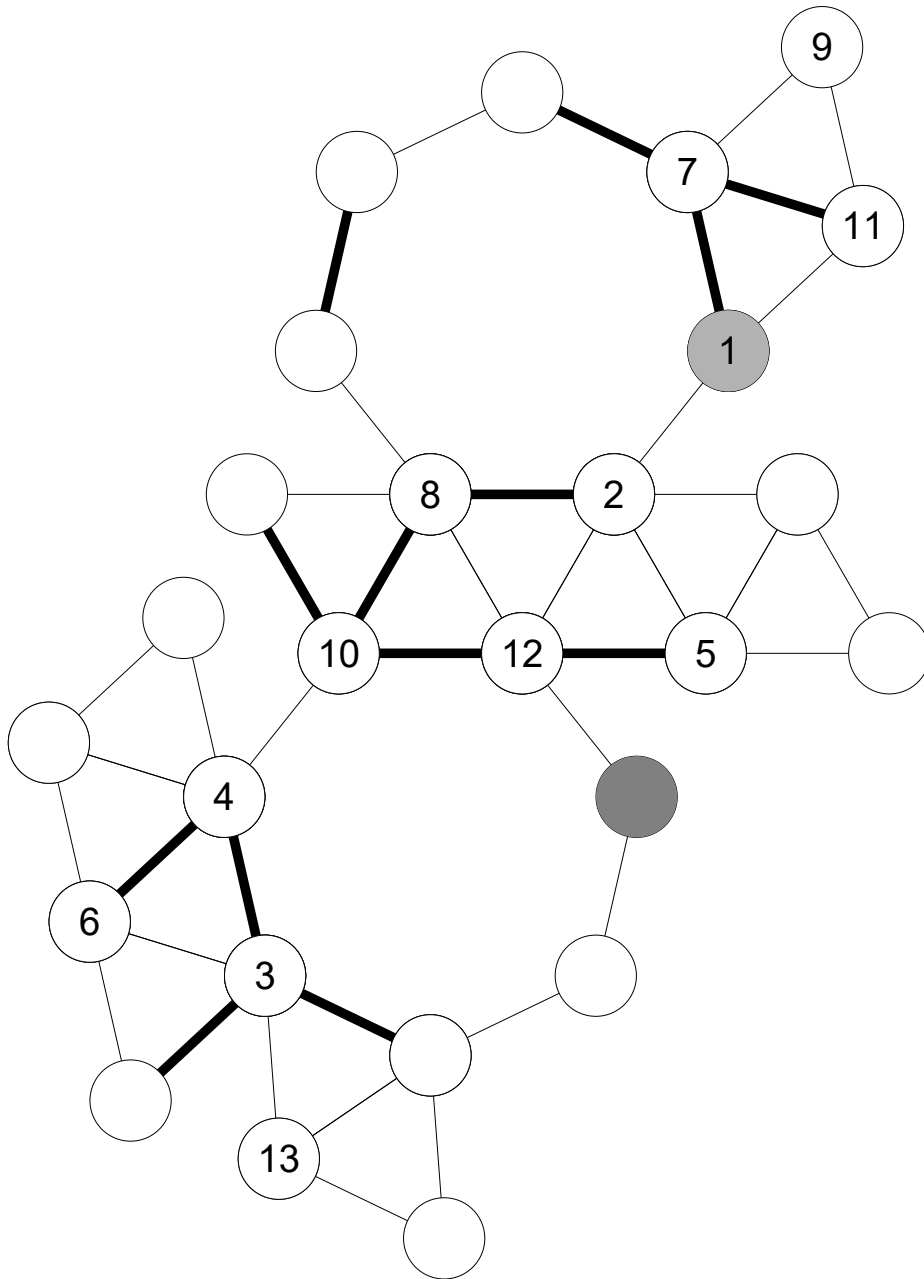

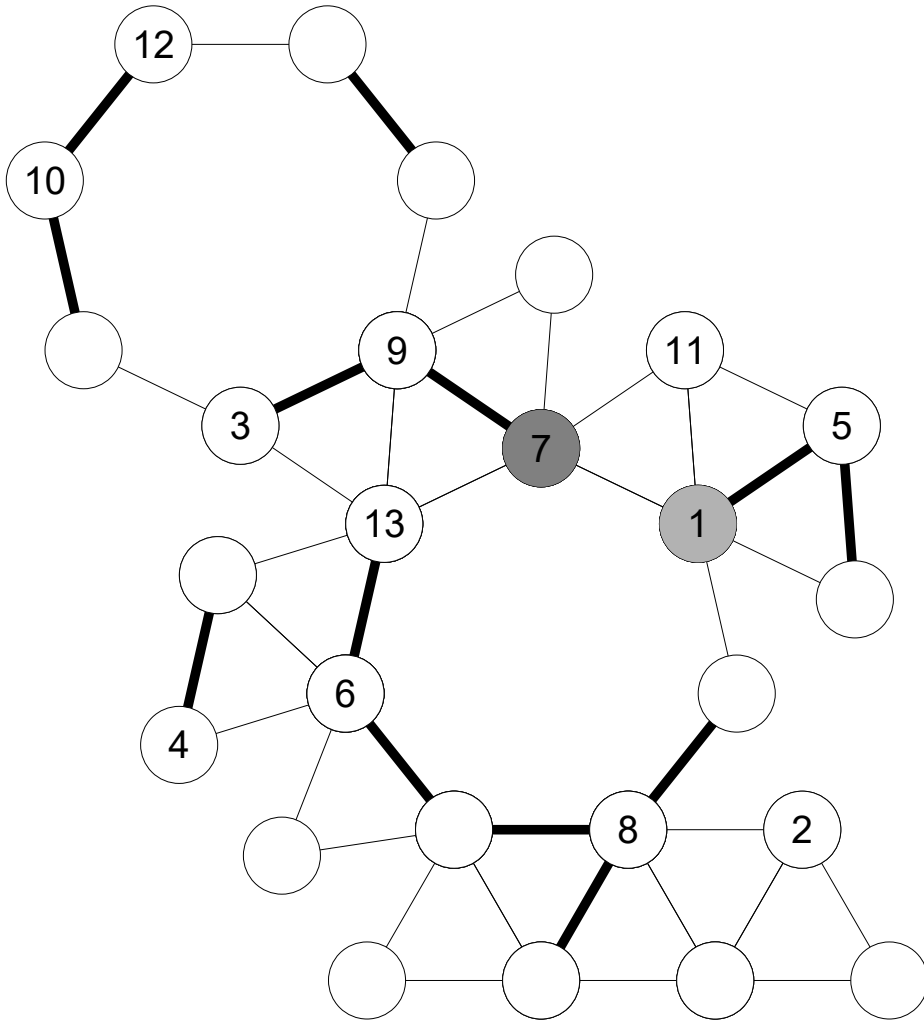

19

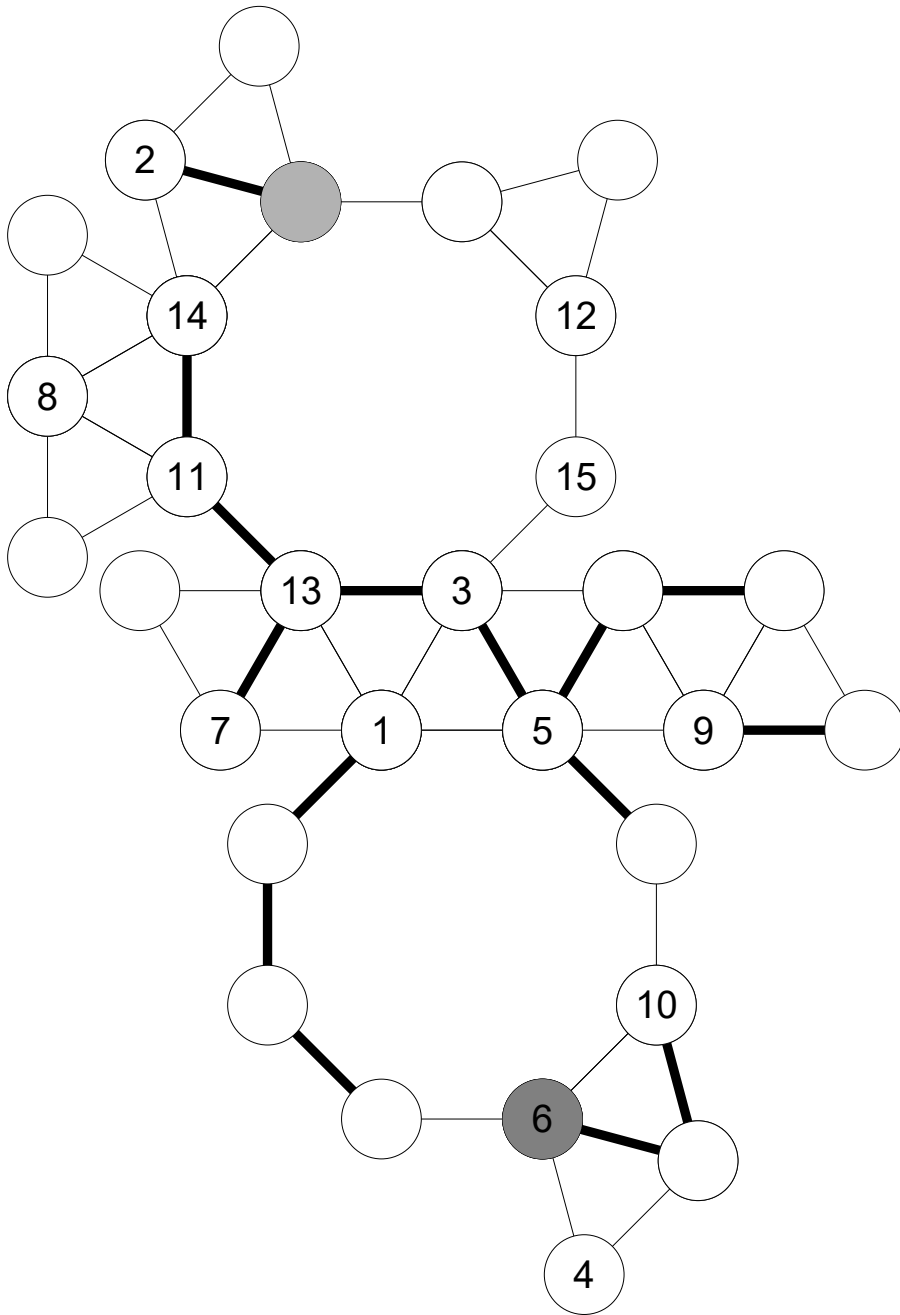

20

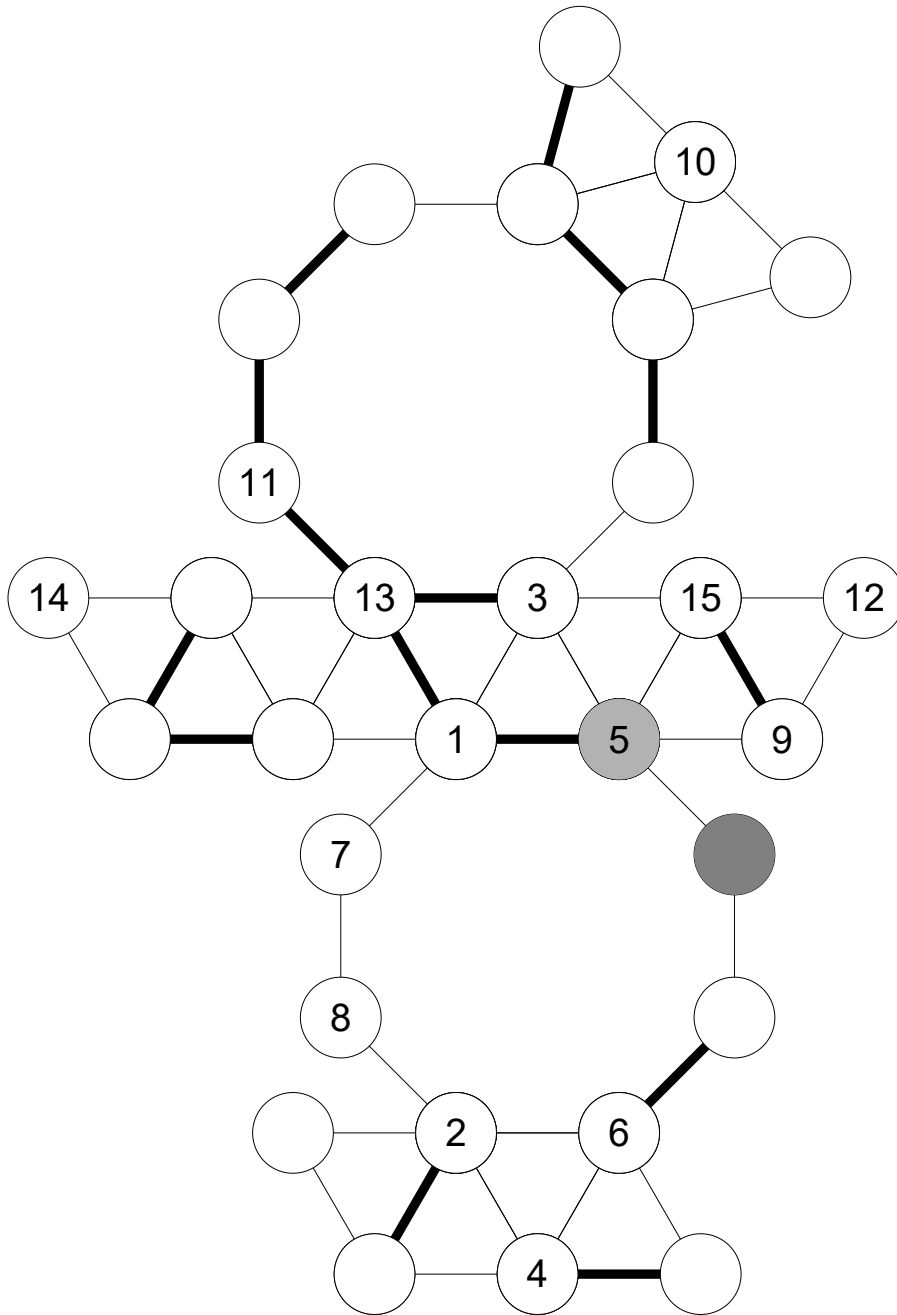

21

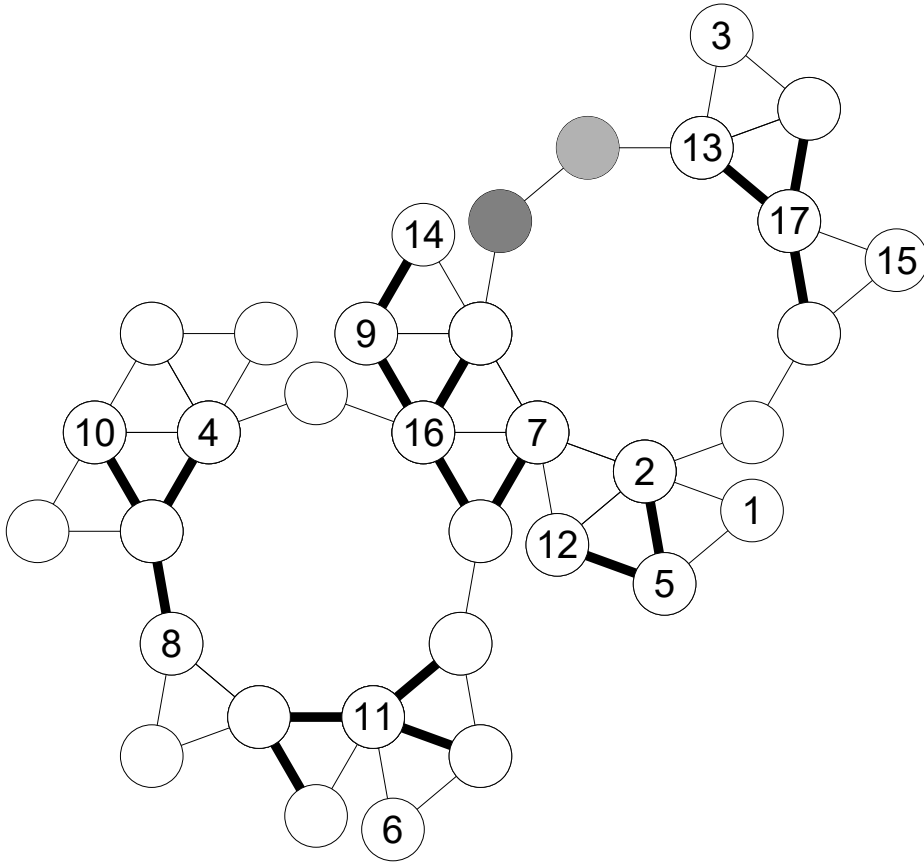

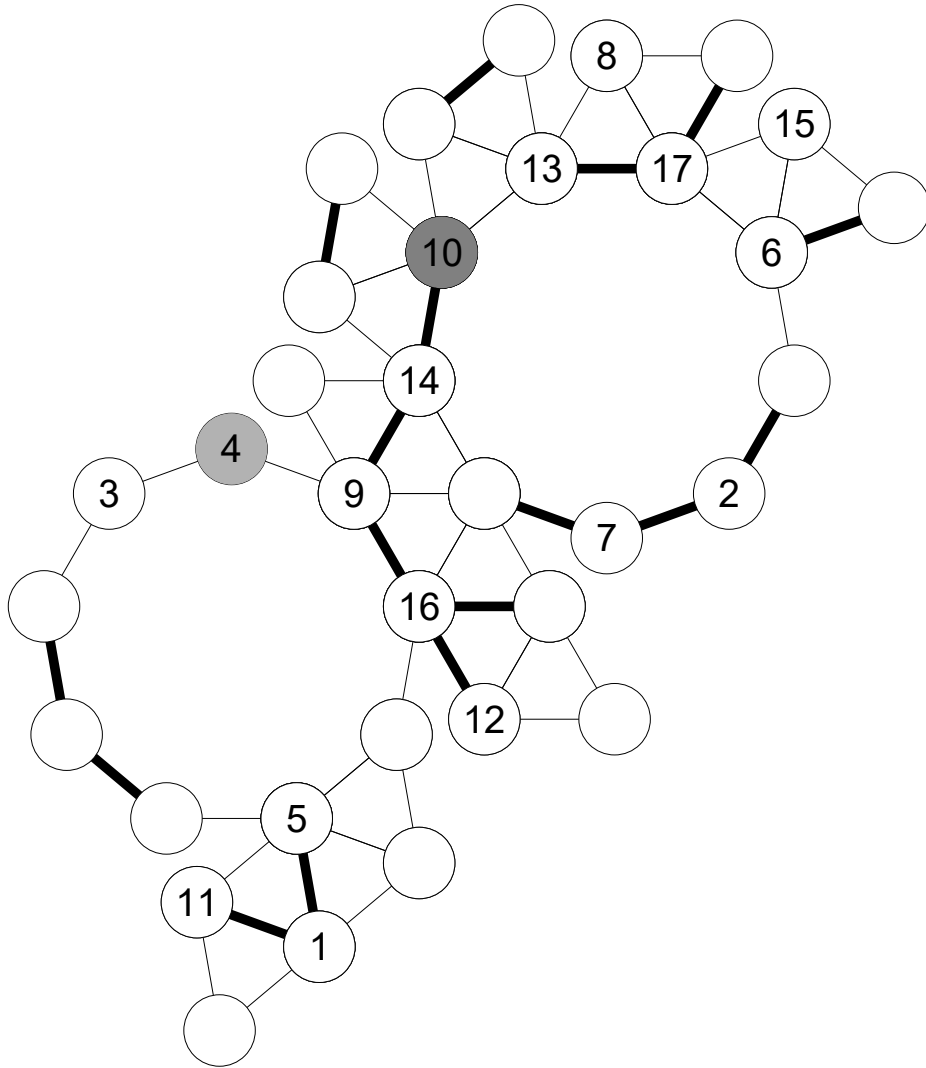



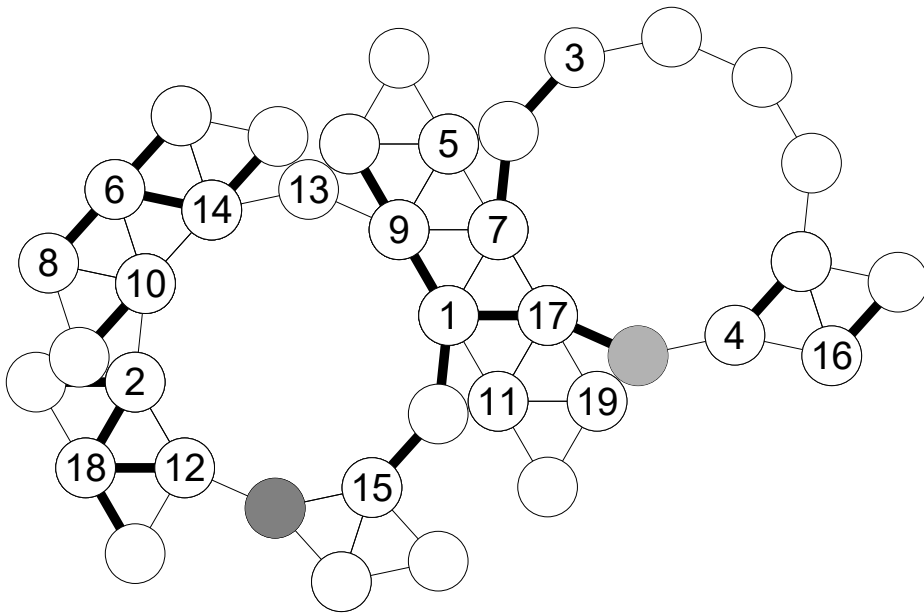



25

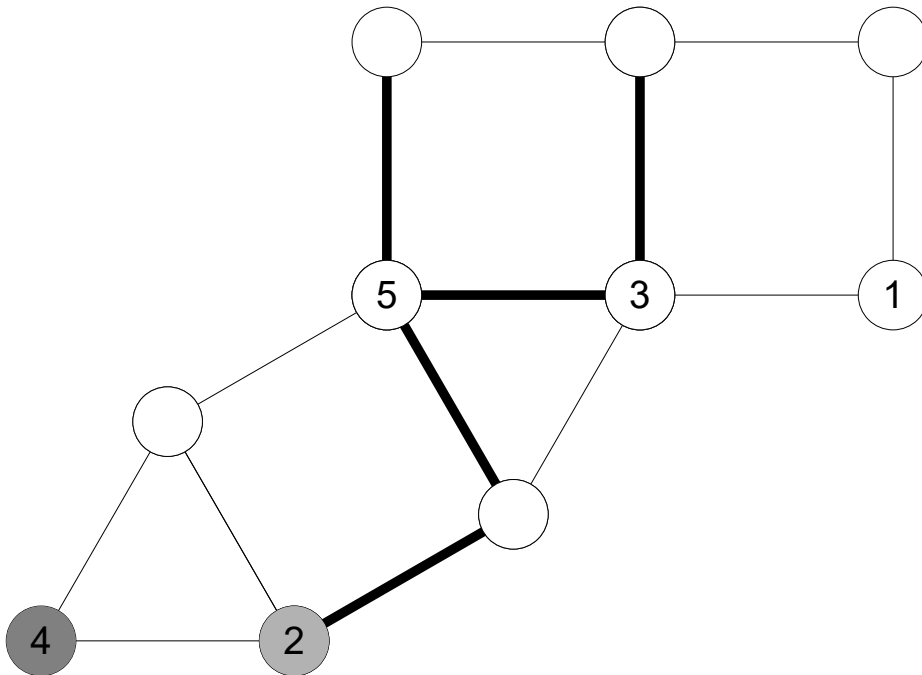

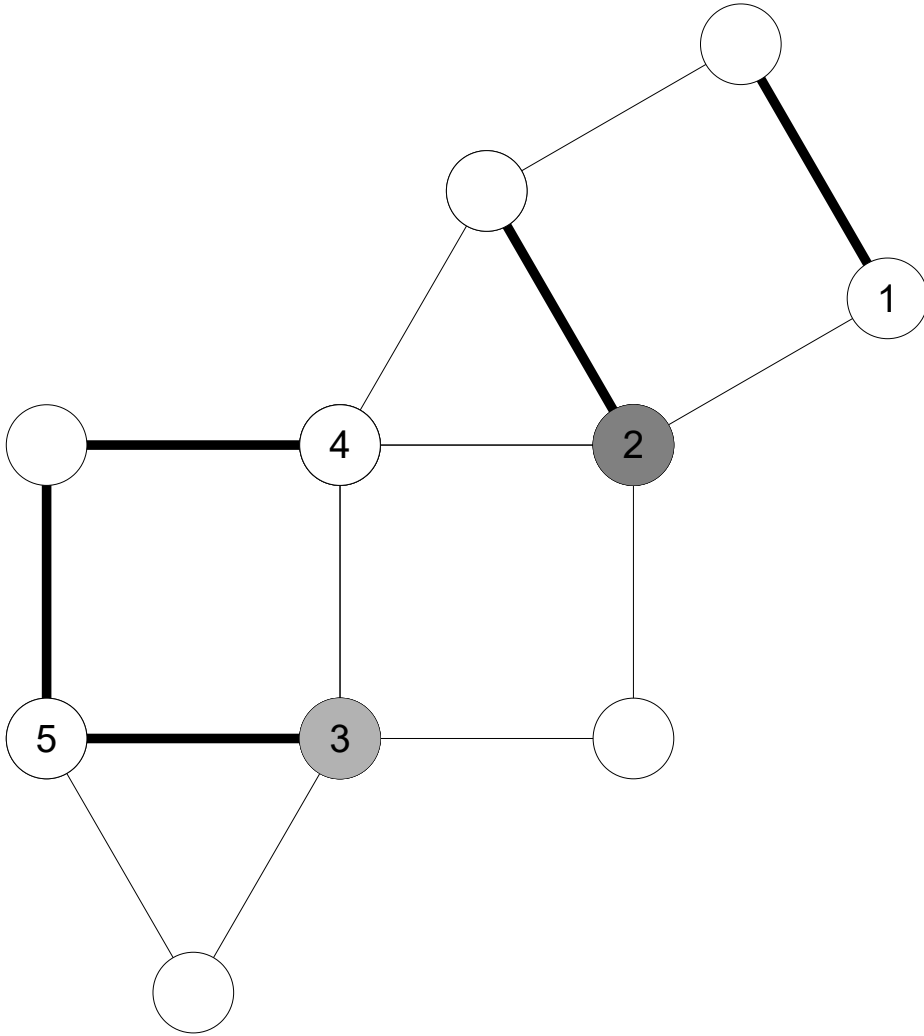

27

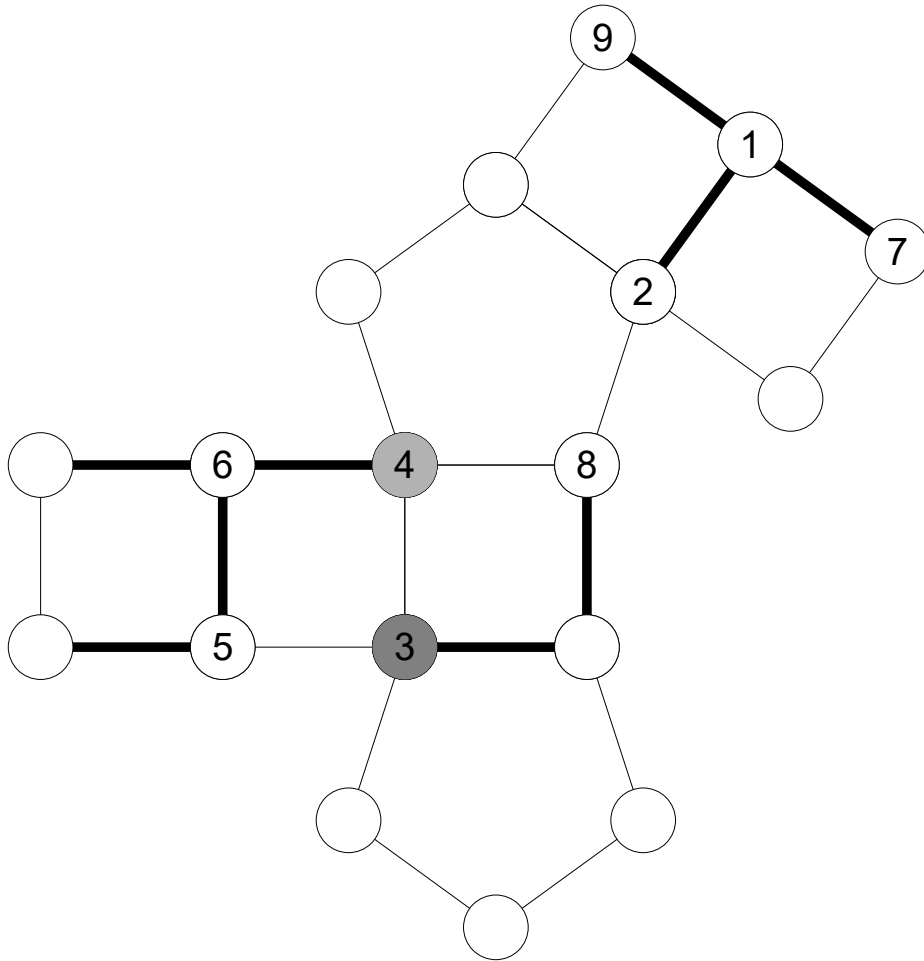

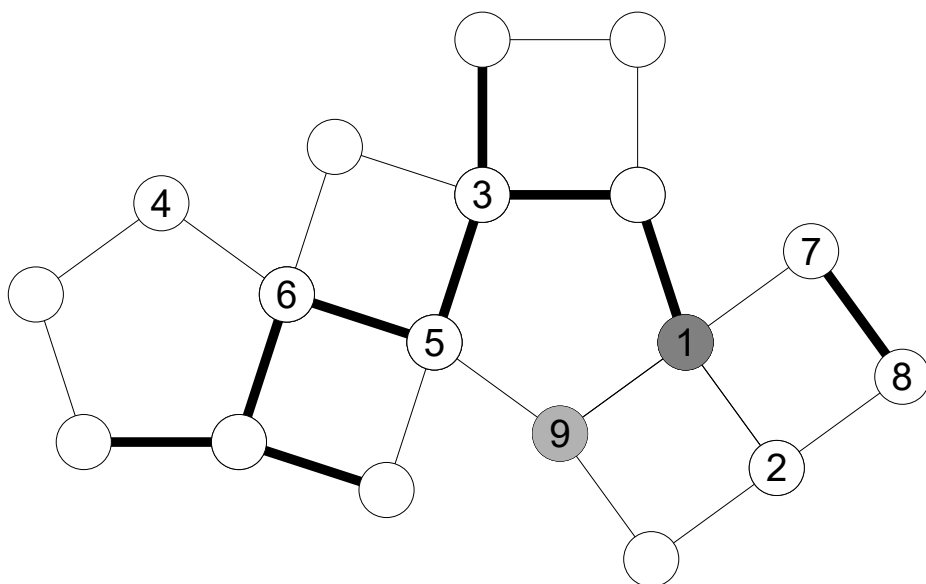

29

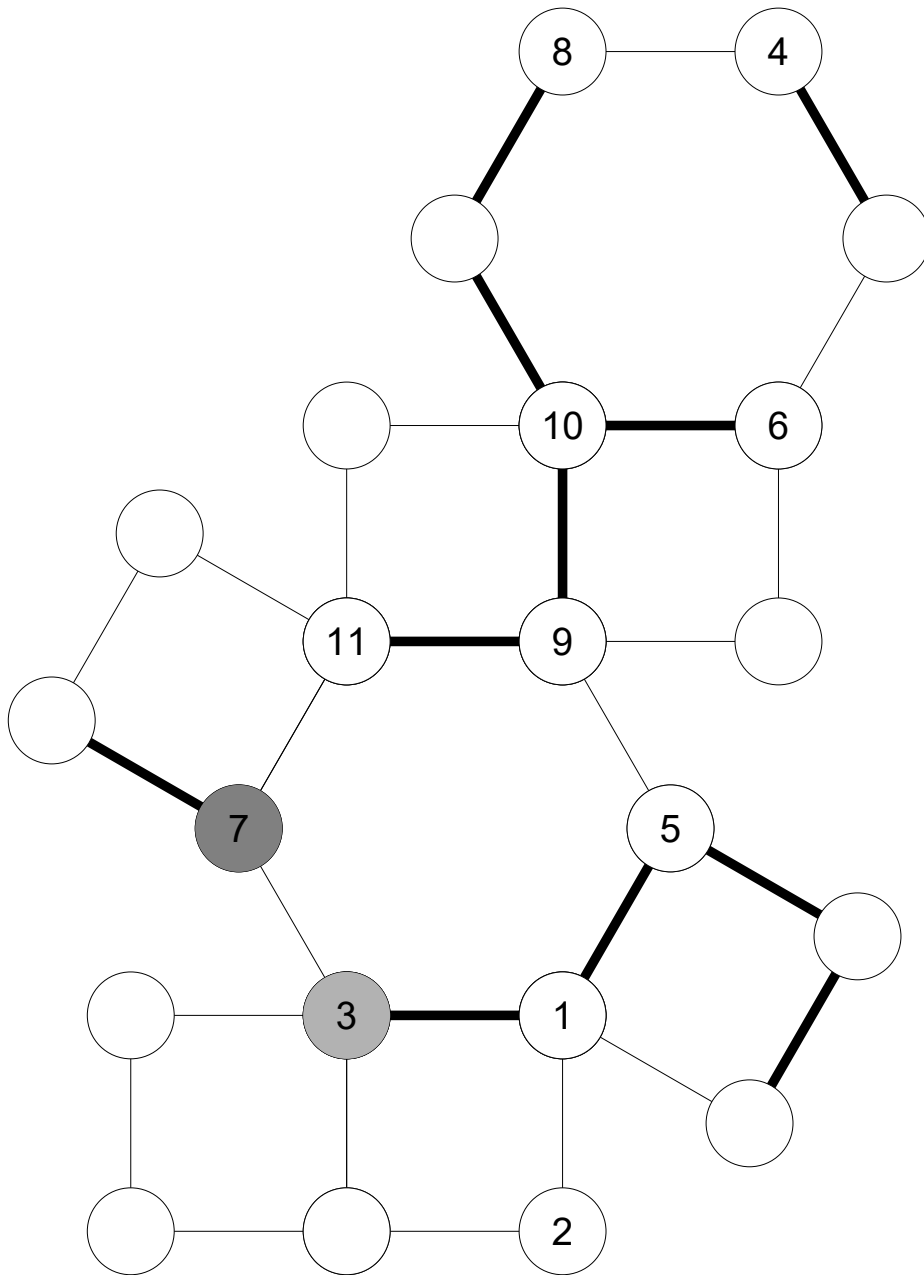

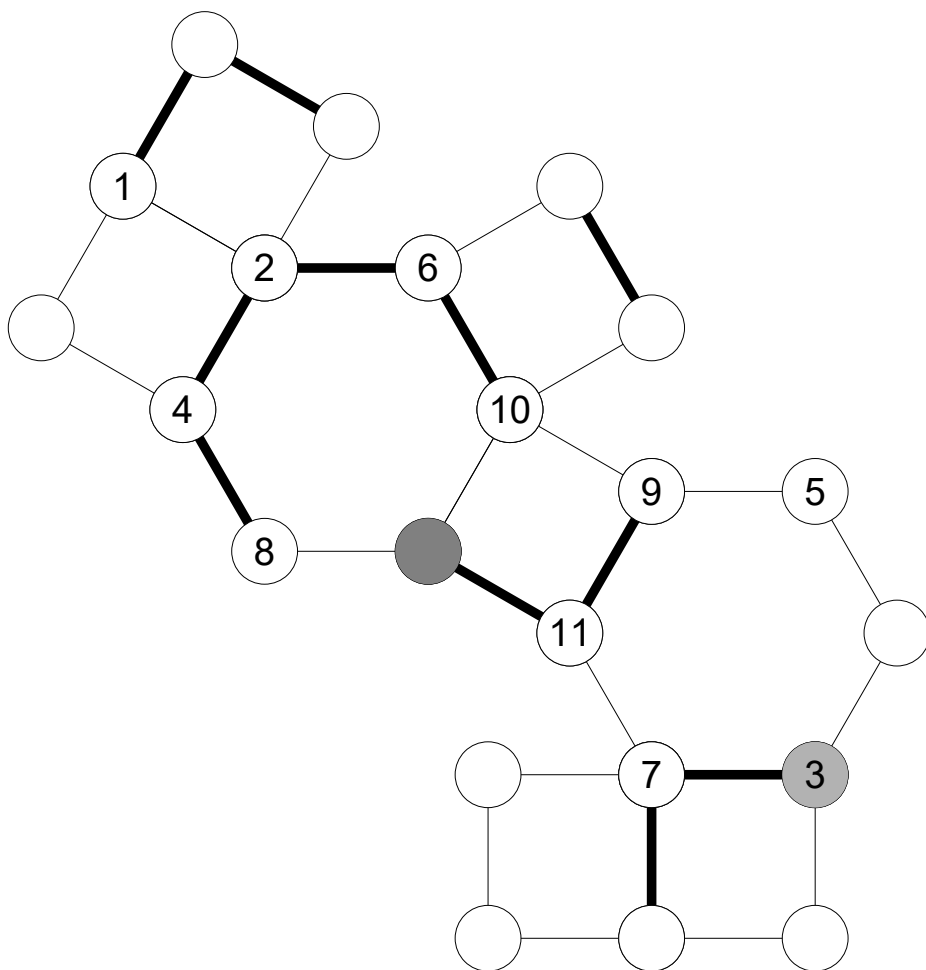



# Odgovori

1

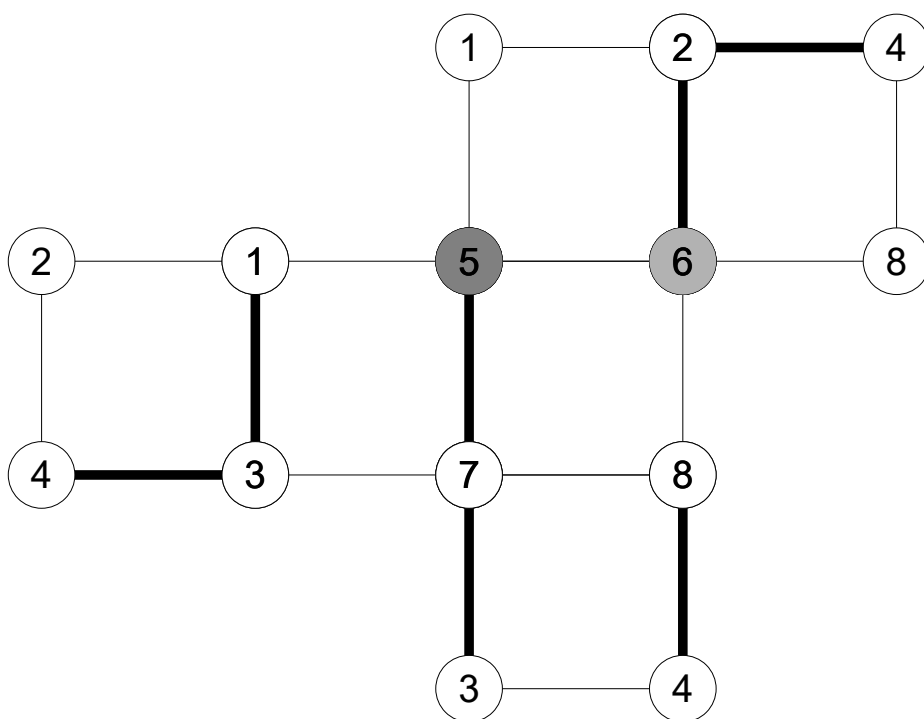

{5, 7, 3, 4, 2, 6}

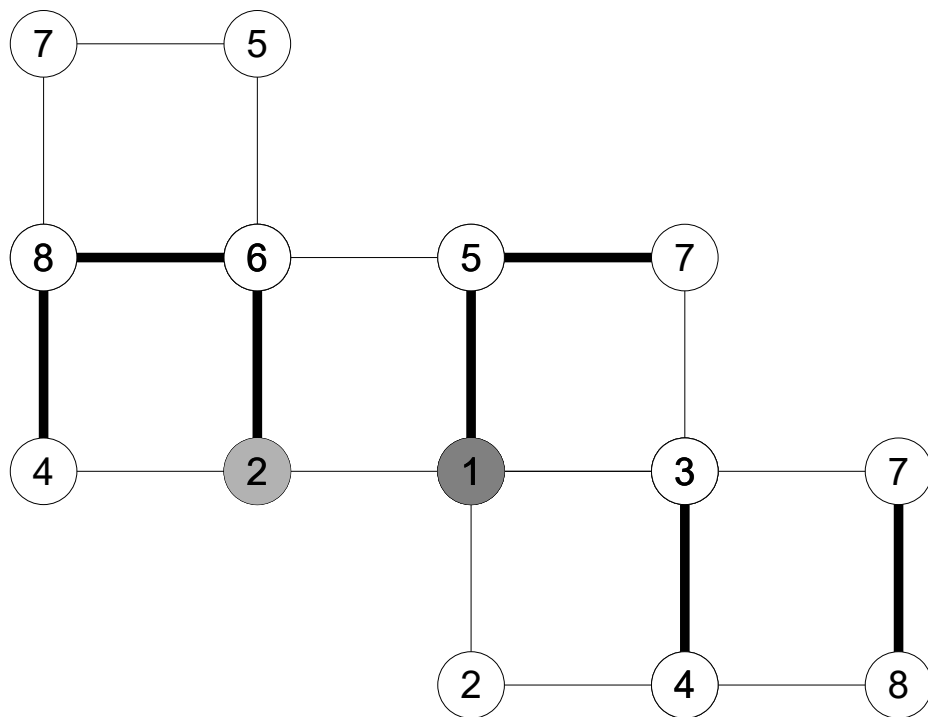

{1, 5, 7, 8, 6, 2}

3

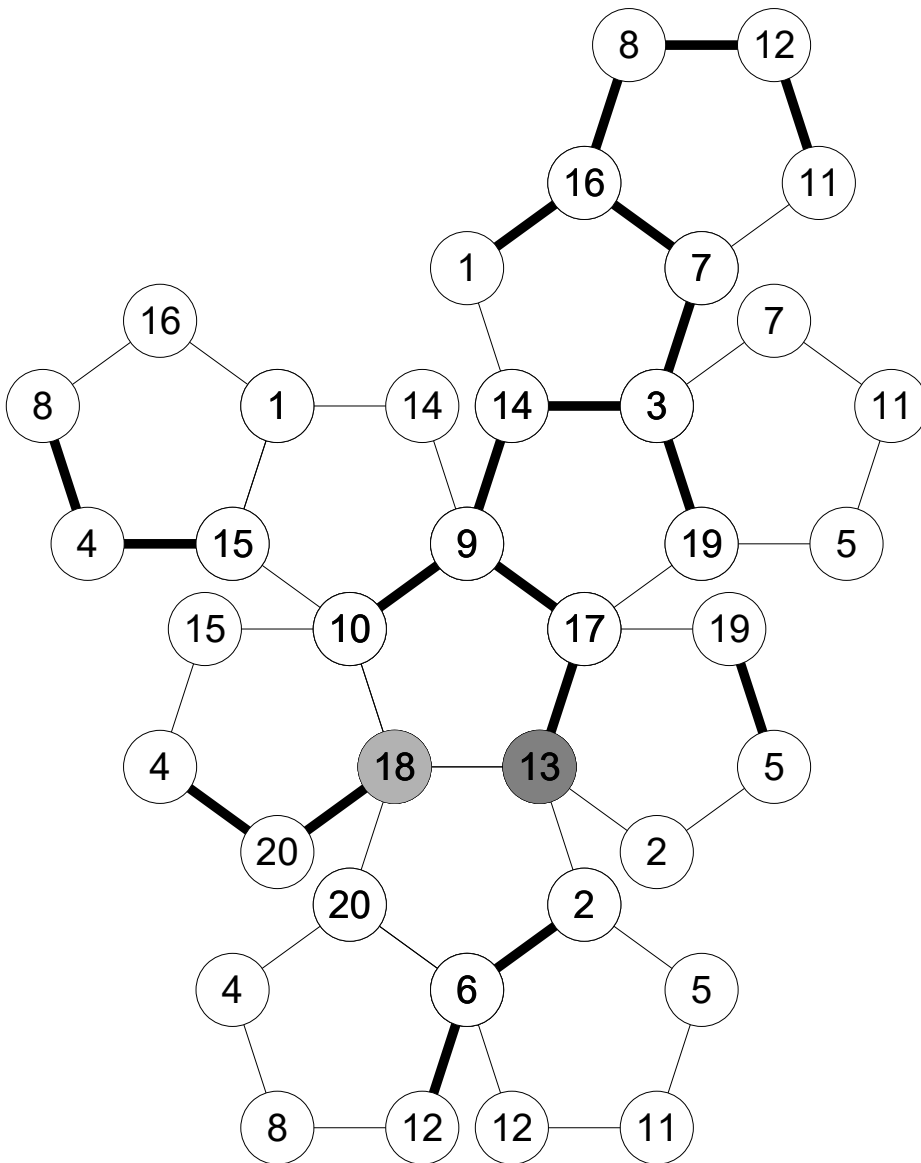

{13, 17, 9, 14, 3, 7, 16, 8, 4, 20, 18}

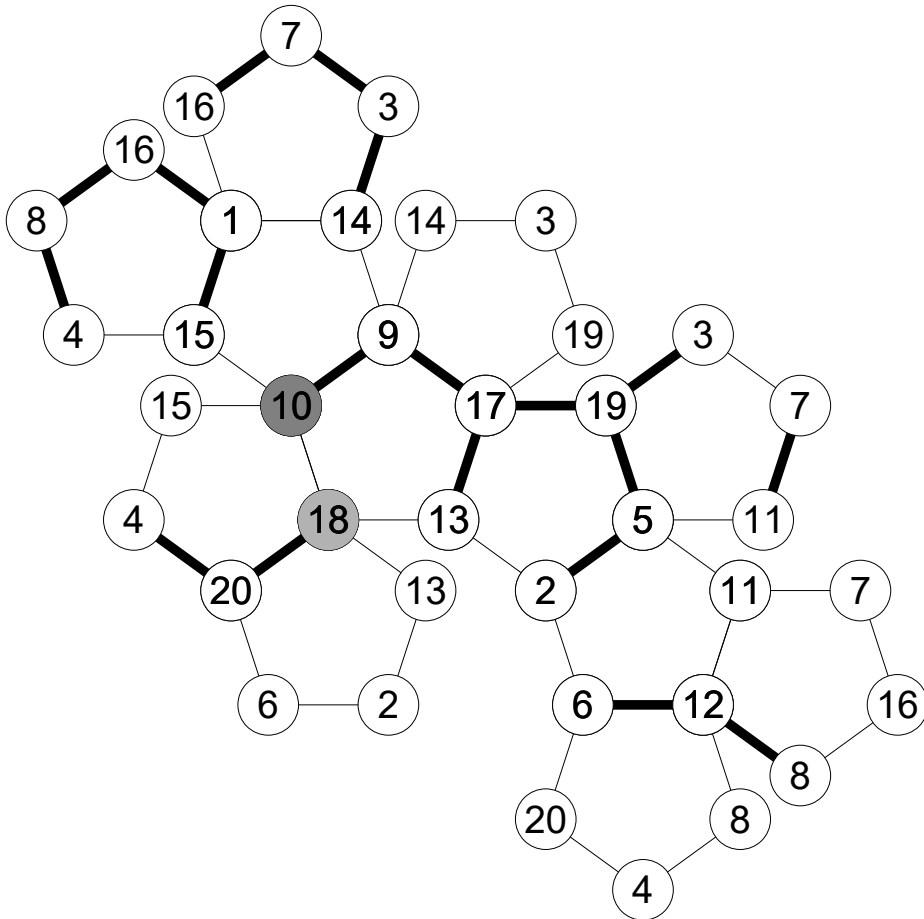

{10, 9, 17, 19, 3, 7, 16, 8, 4, 20, 18}

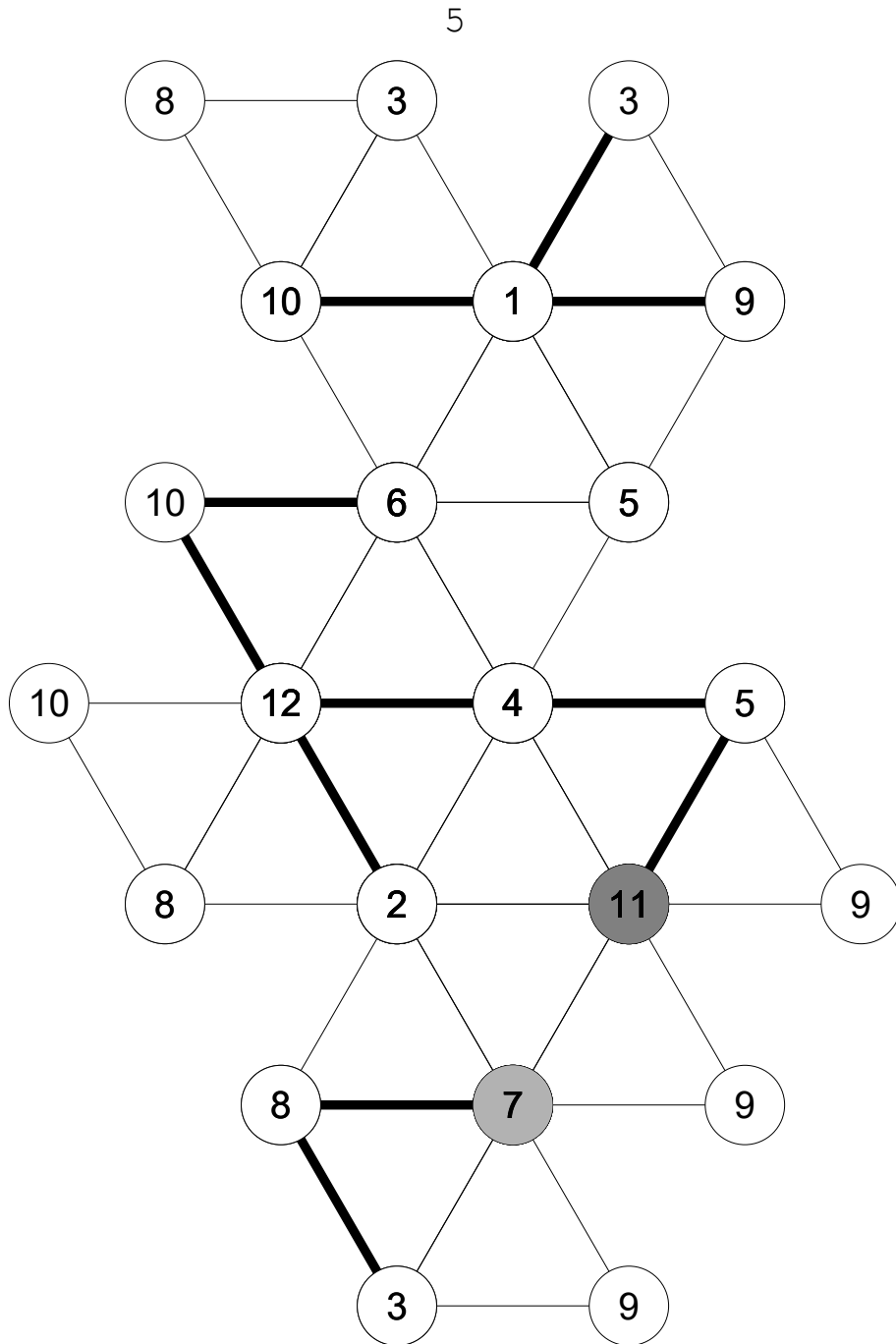

{11, 5, 4, 12, 10, 1, 3, 8, 7}

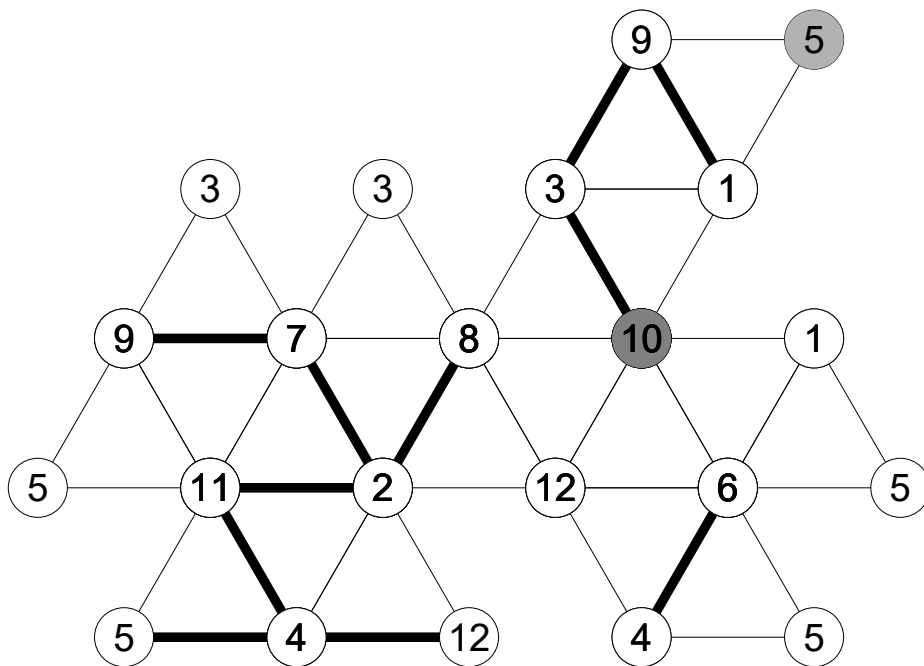

{10, 3, 9, 7, 2, 11, 4, 5}

7

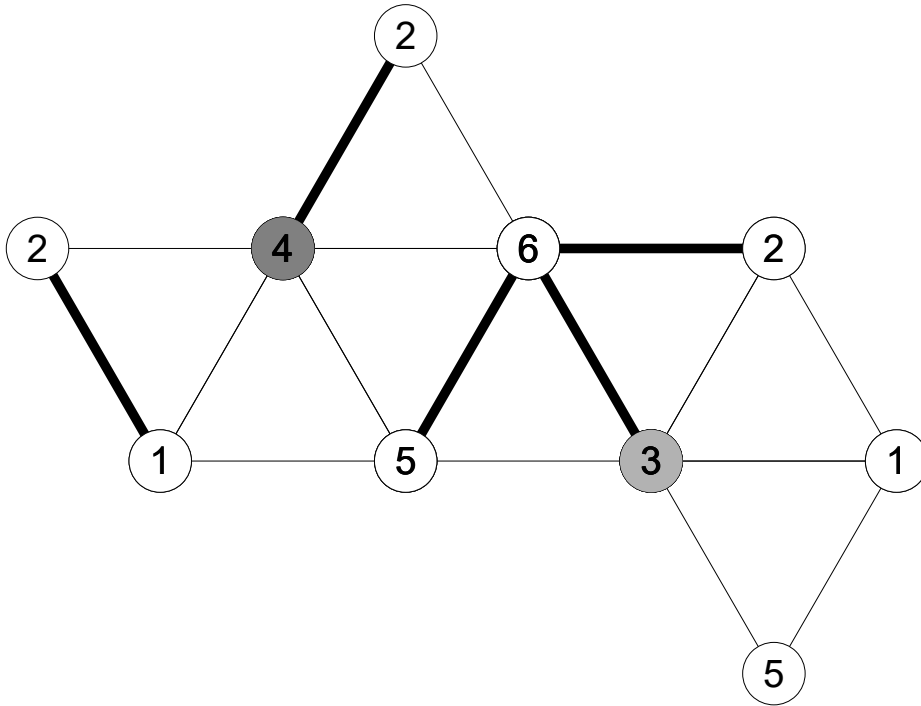

{4, 2, 6, 3}

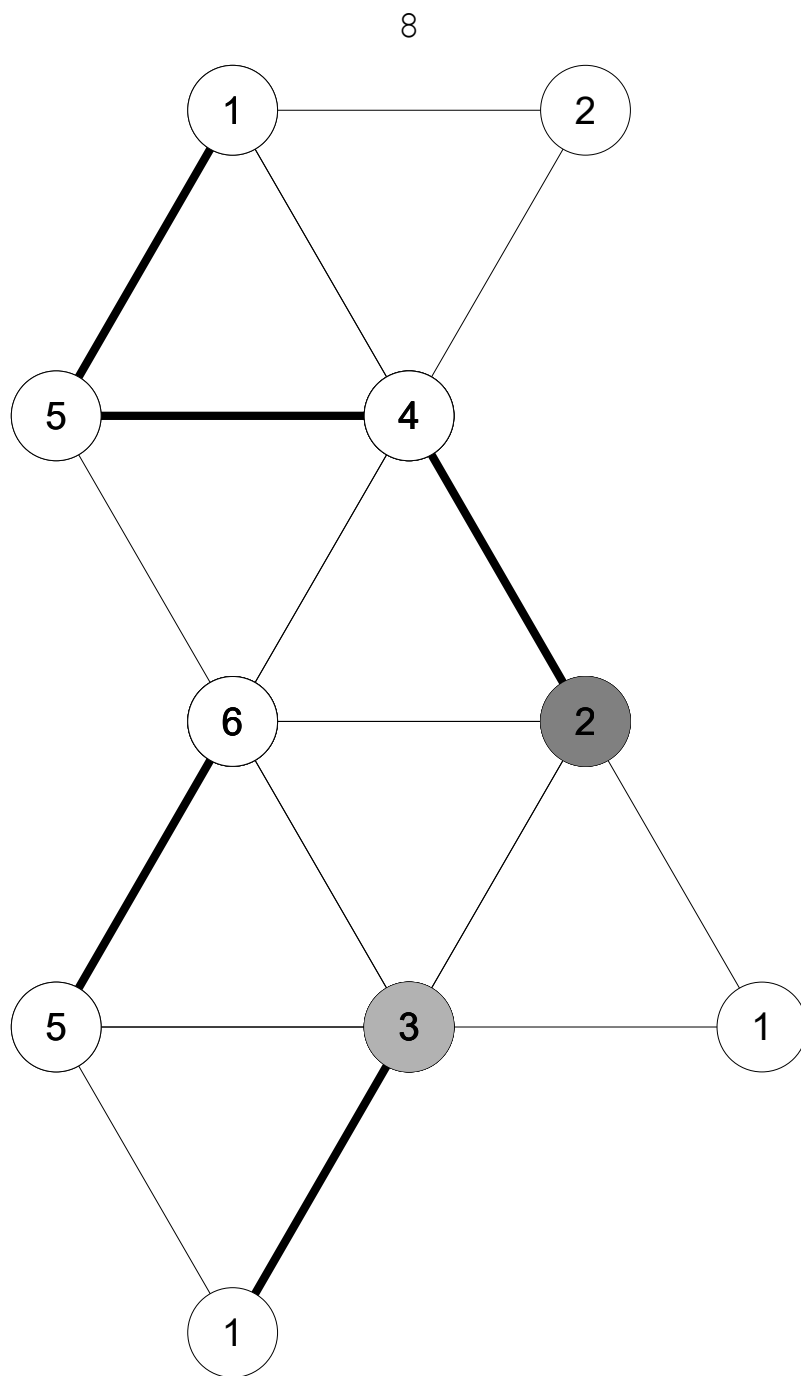

{2, 4, 5, 1, 3}



9

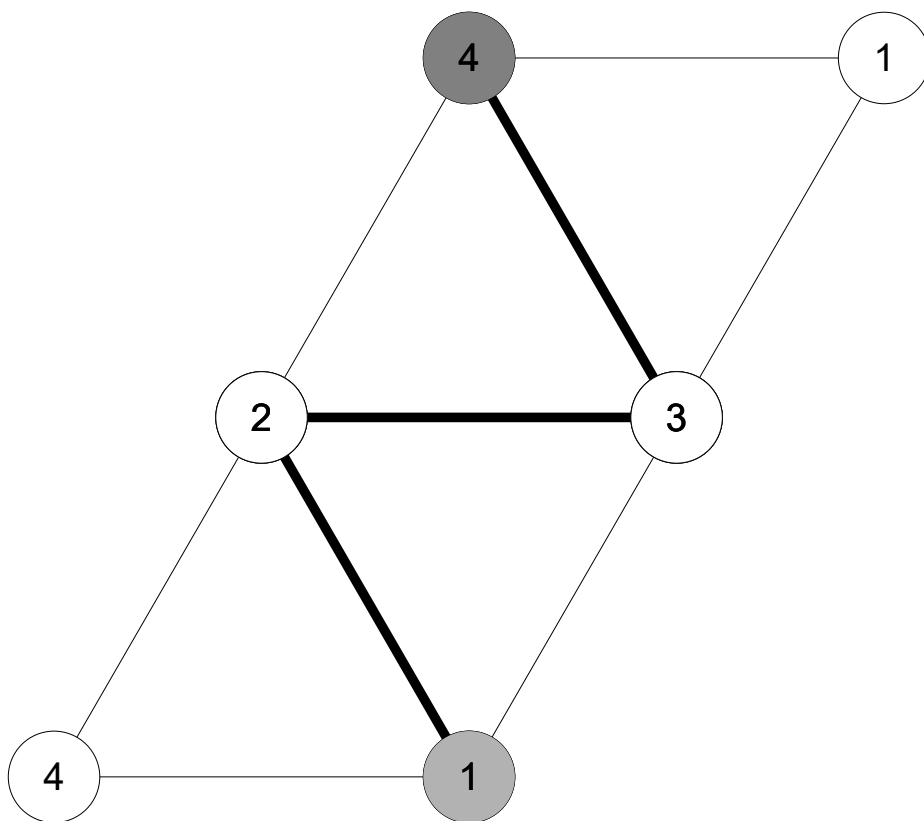

{4, 3, 2, 1}

10

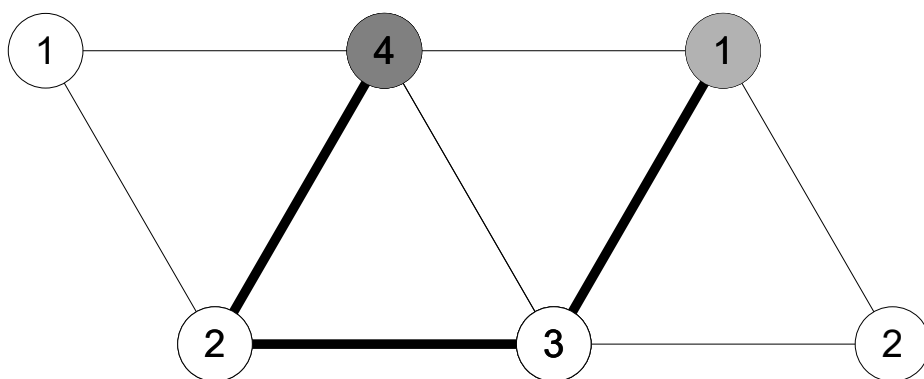

{4, 2, 3, 1}

11

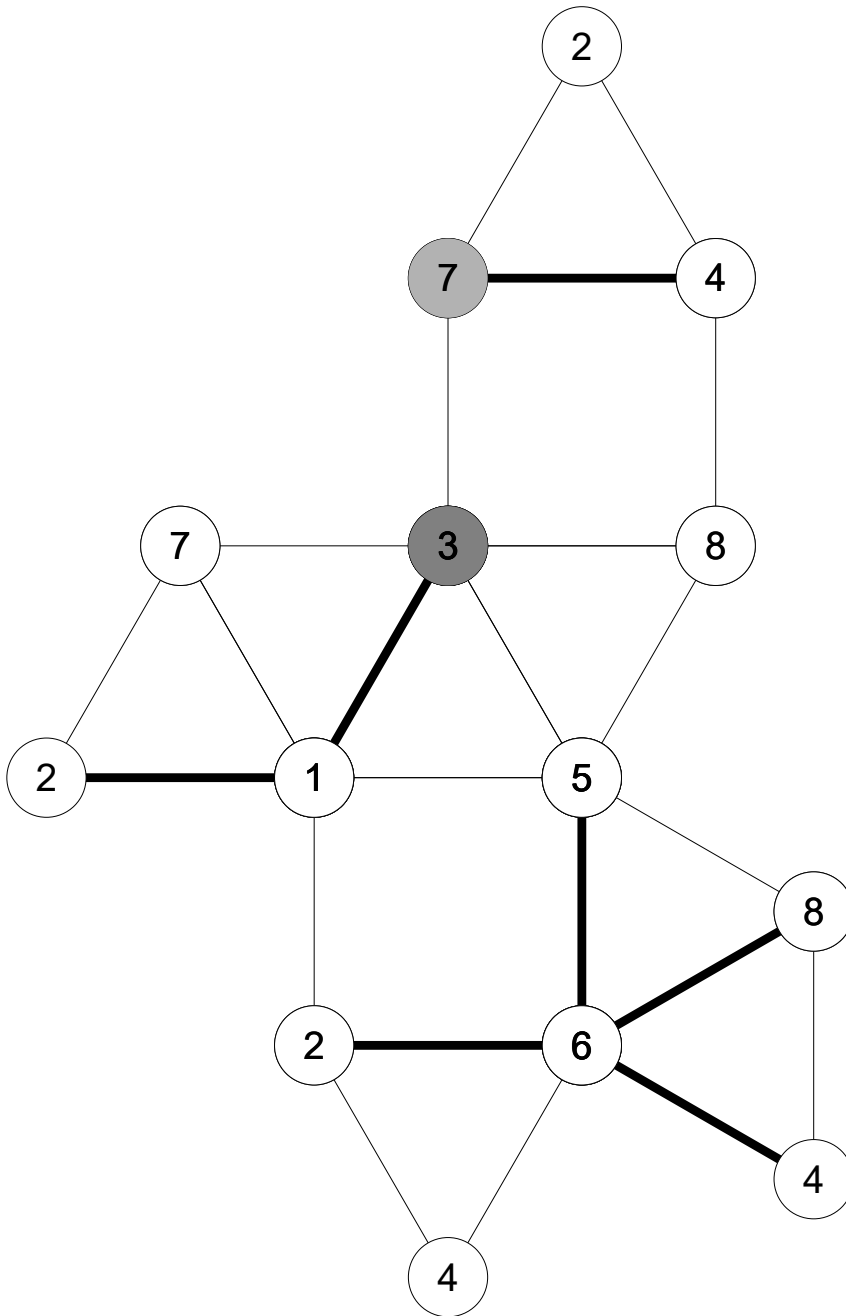

{3, 1, 2, 6, 4, 7}

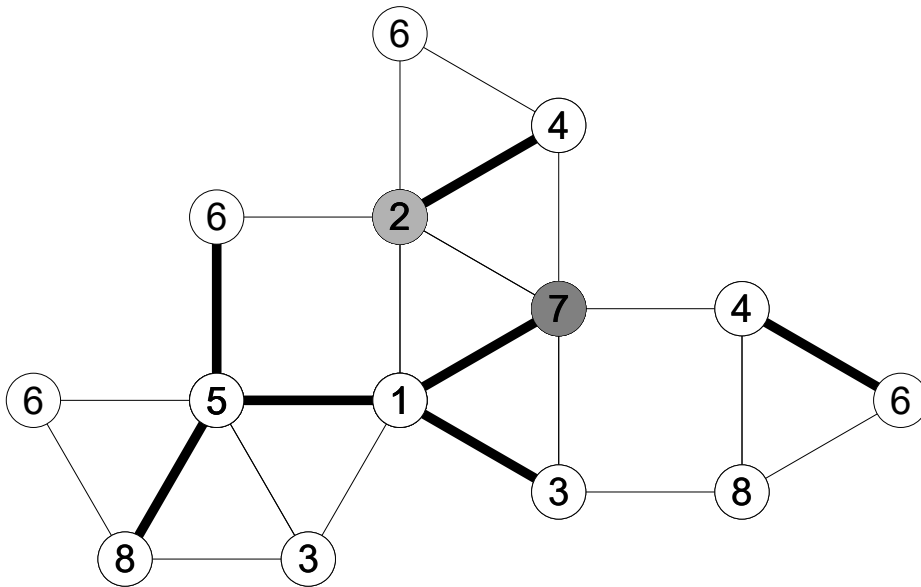

{7, 1, 5, 6, 4, 2}

13

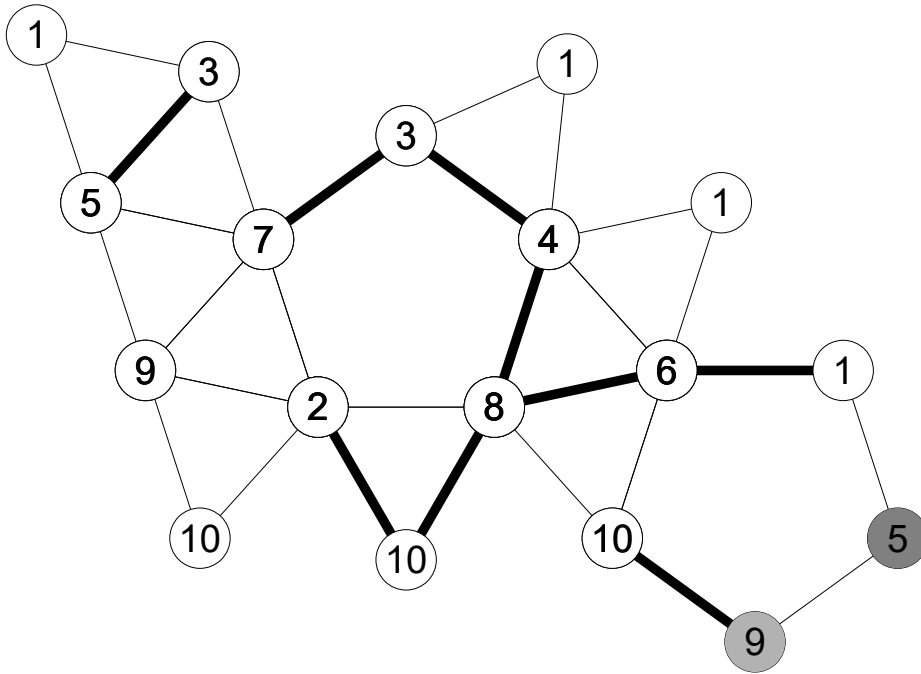

{5, 3, 4, 8, 10, 9}

14

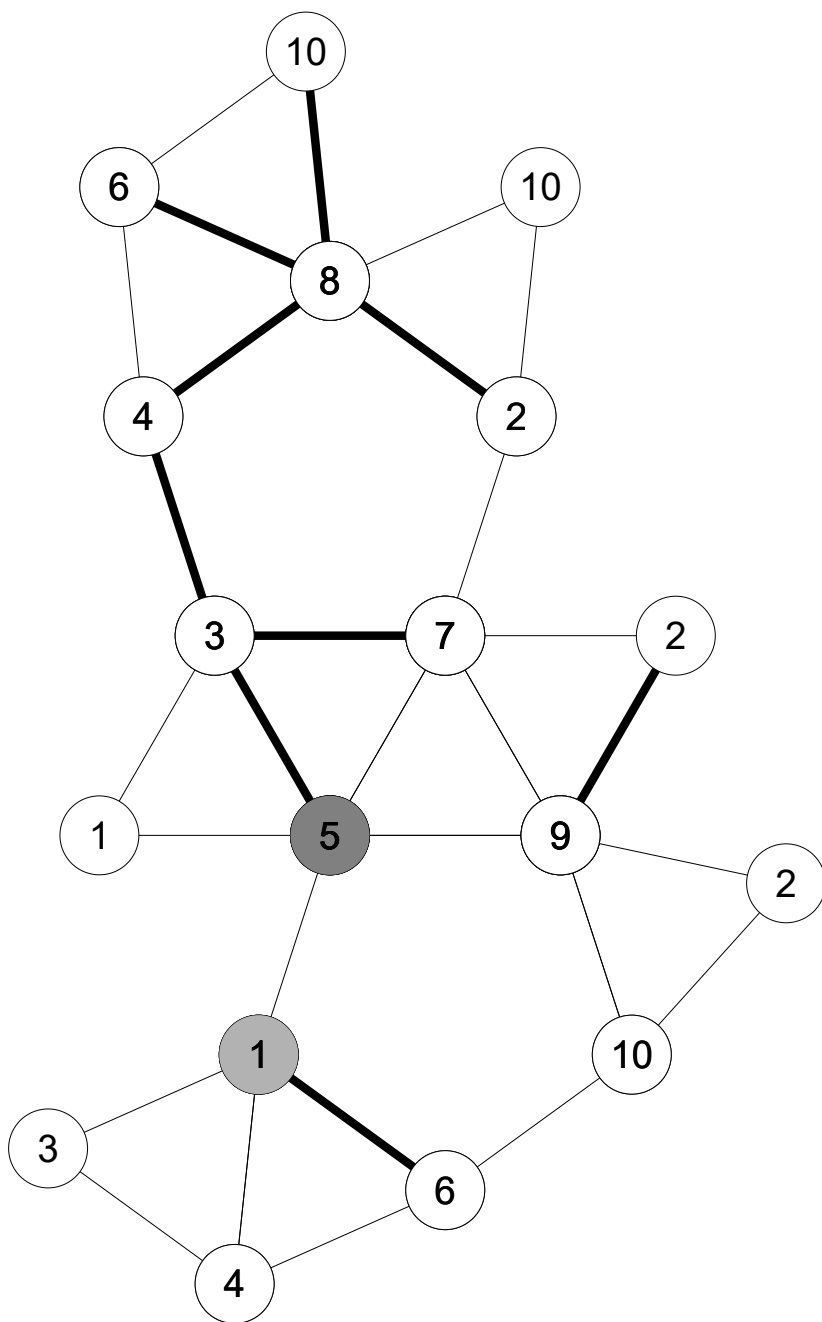

{5, 3, 4, 8, 6, 1}

15

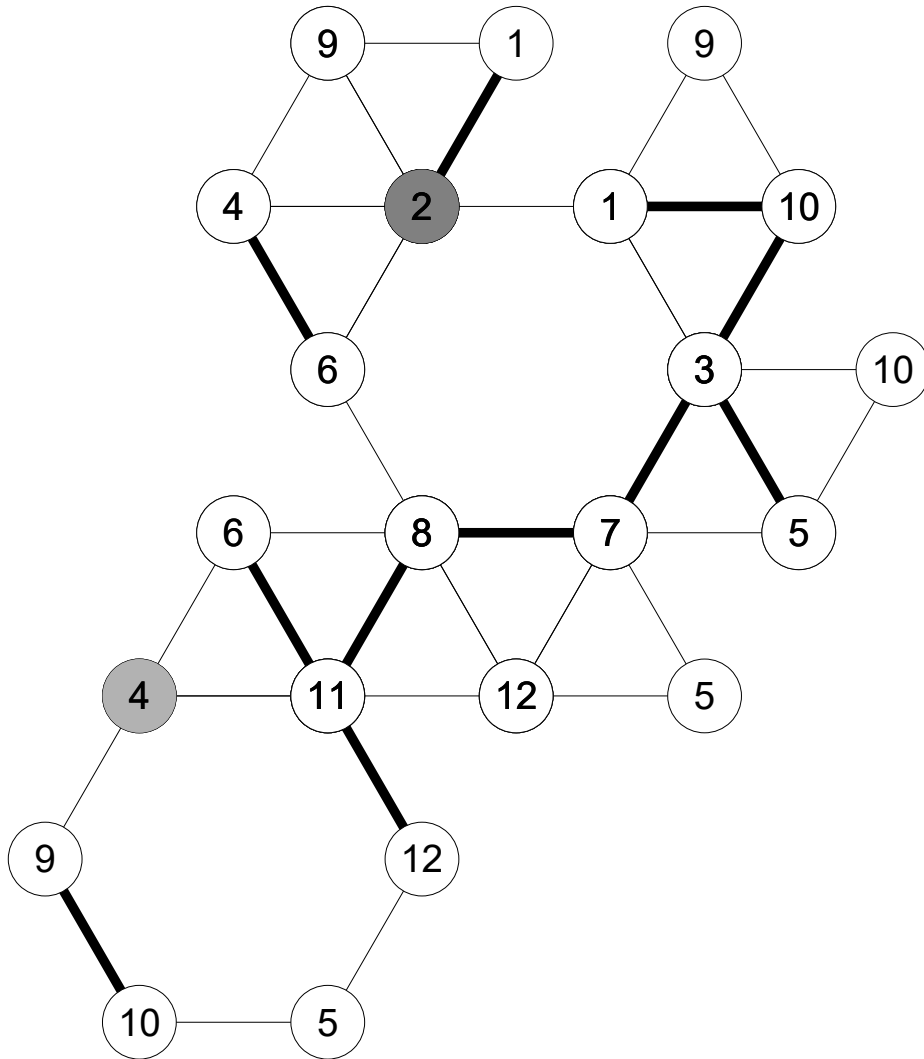

{2, 1, 10, 3, 7, 8, 11, 6, 4}

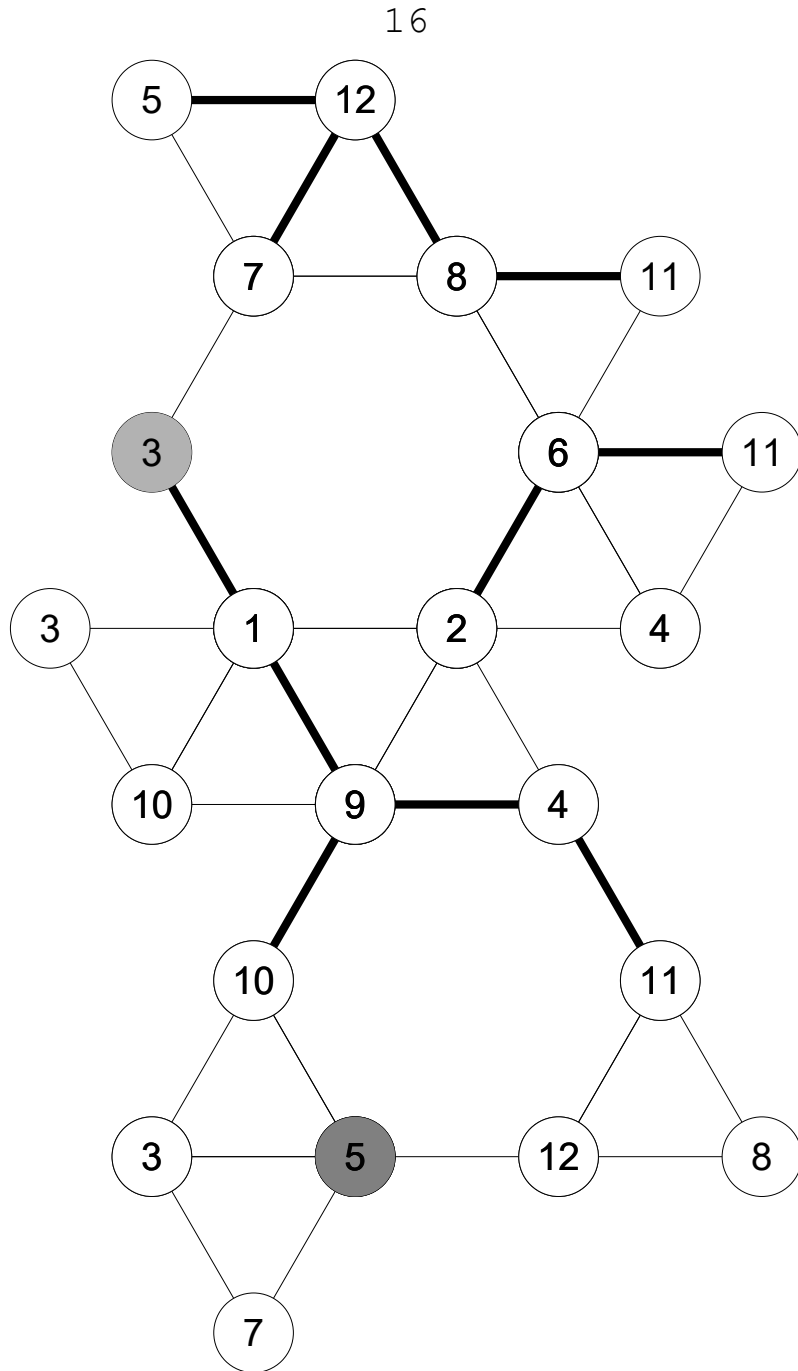

{5, 12, 8, 11, 4, 9, 1, 3}



17

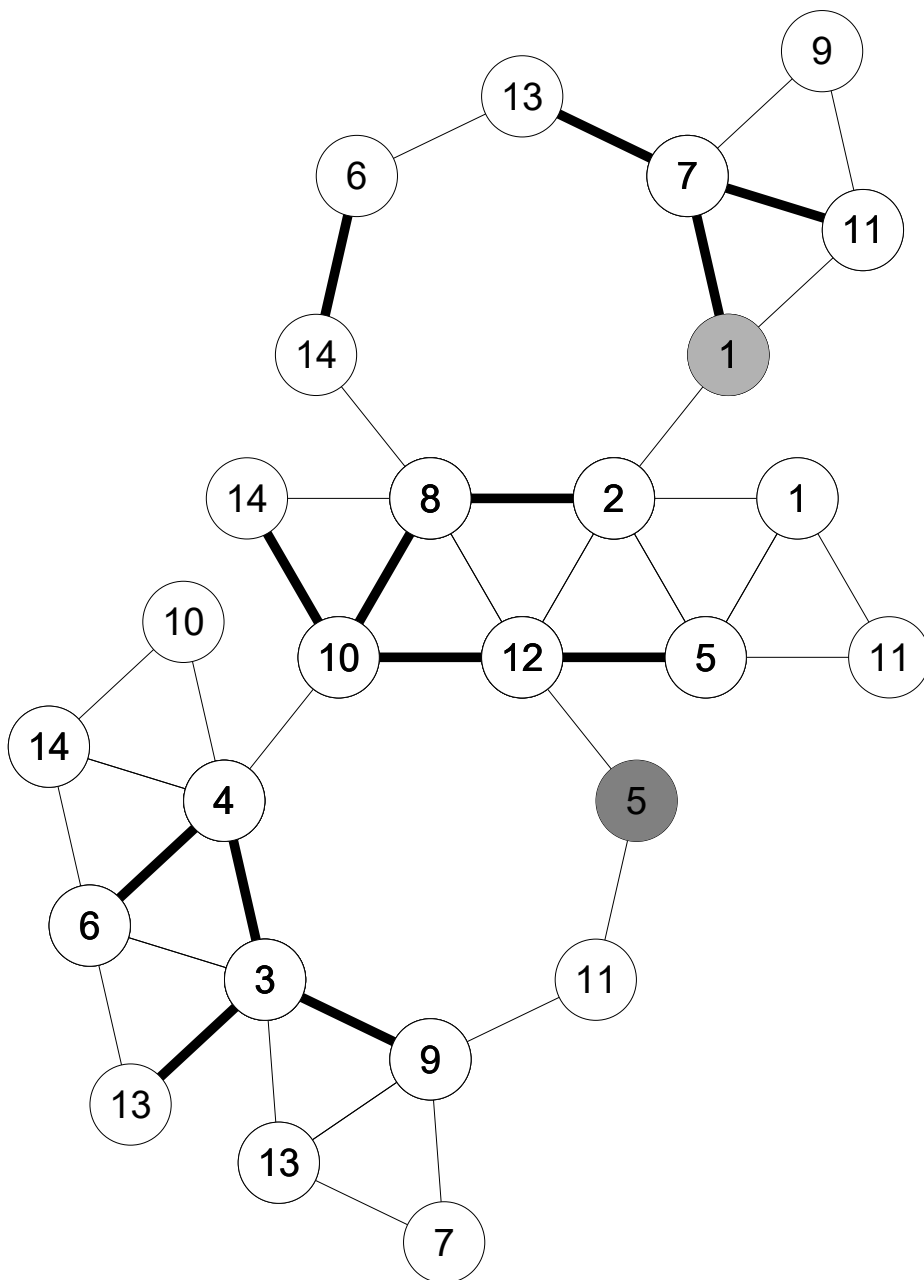

{5, 12, 10, 14, 6, 4, 3, 13, 7, 1}

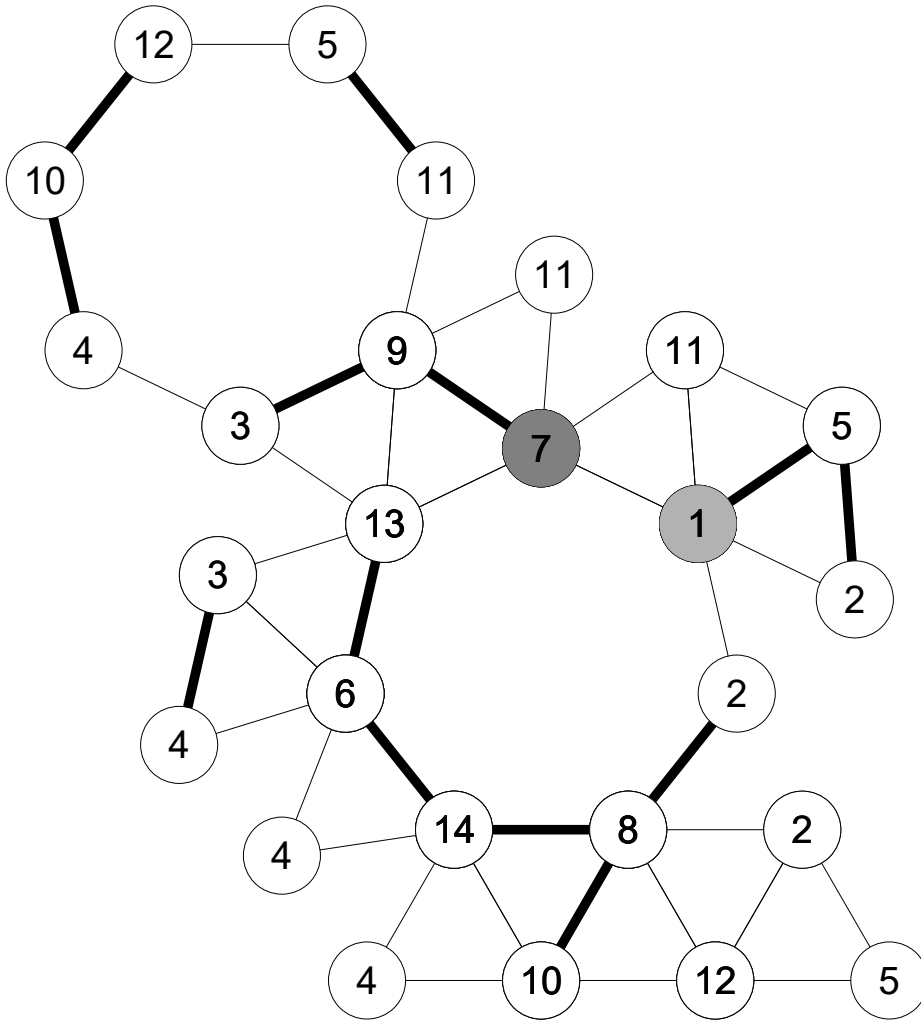

{7, 9, 3, 4, 10, 8, 2, 5, 1}

19

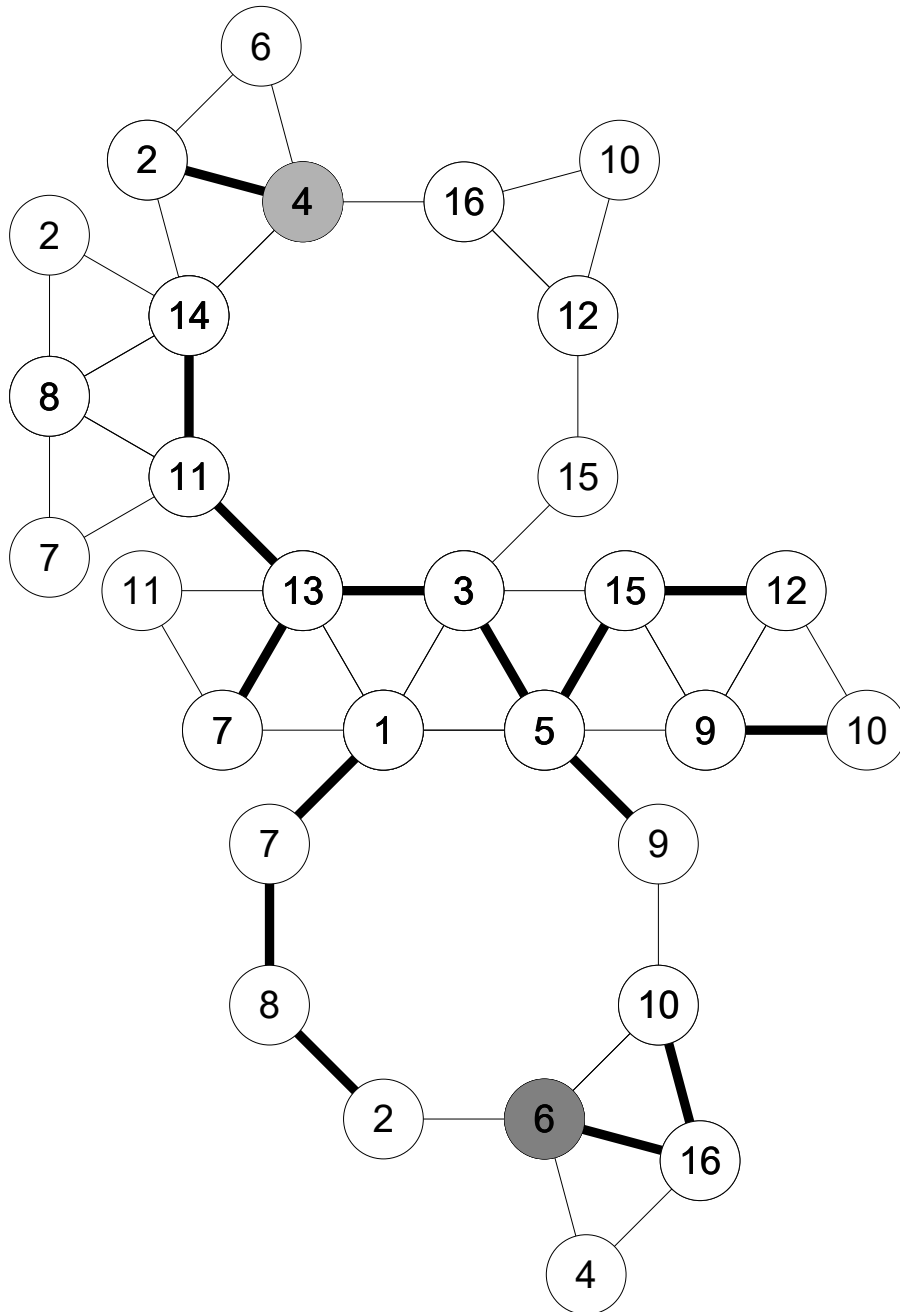

{6, 16, 10, 9, 5, 3, 13, 7, 8, 2, 4}

20

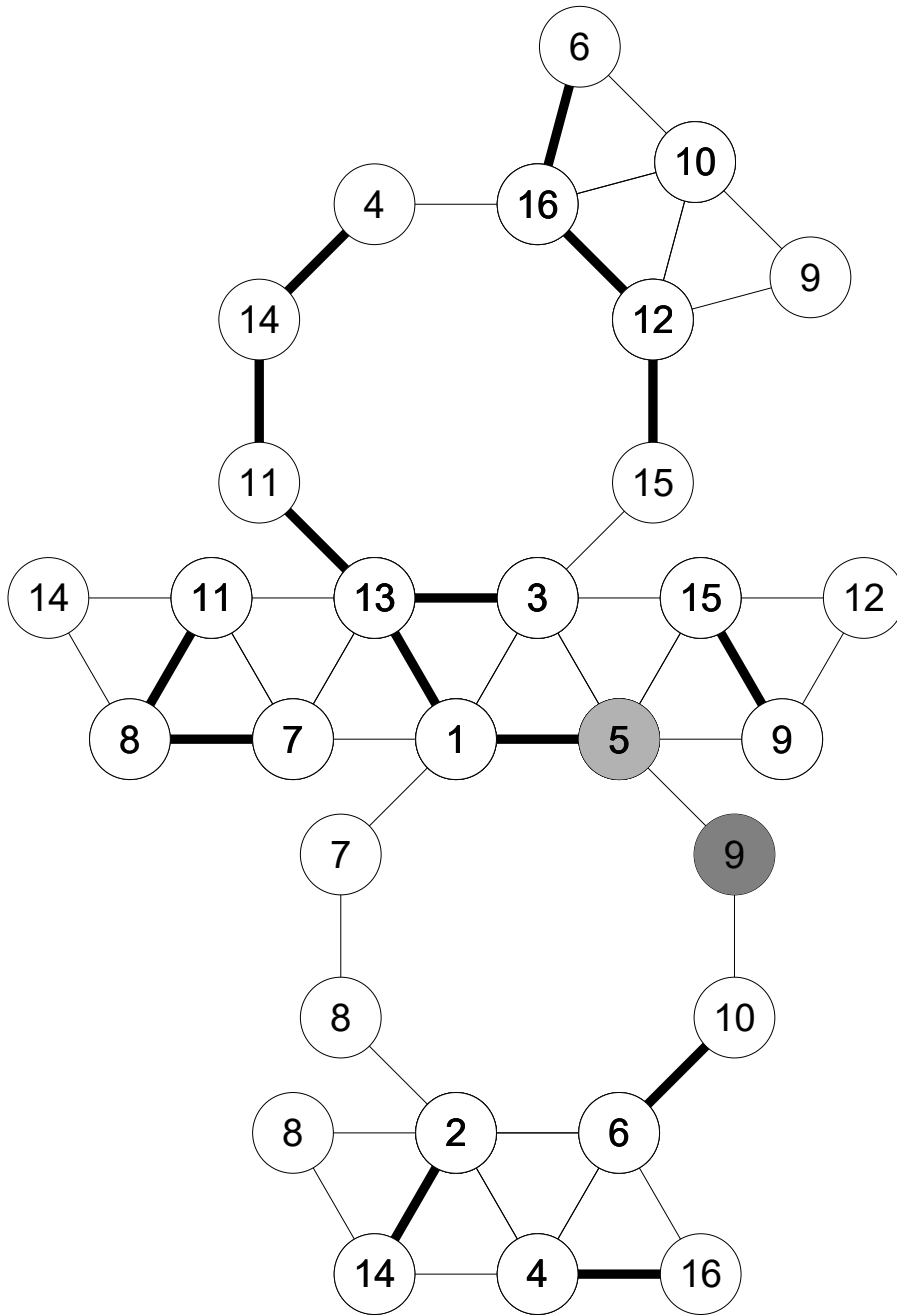

{9, 15, 12, 16, 4, 14, 11, 13, 1, 5}

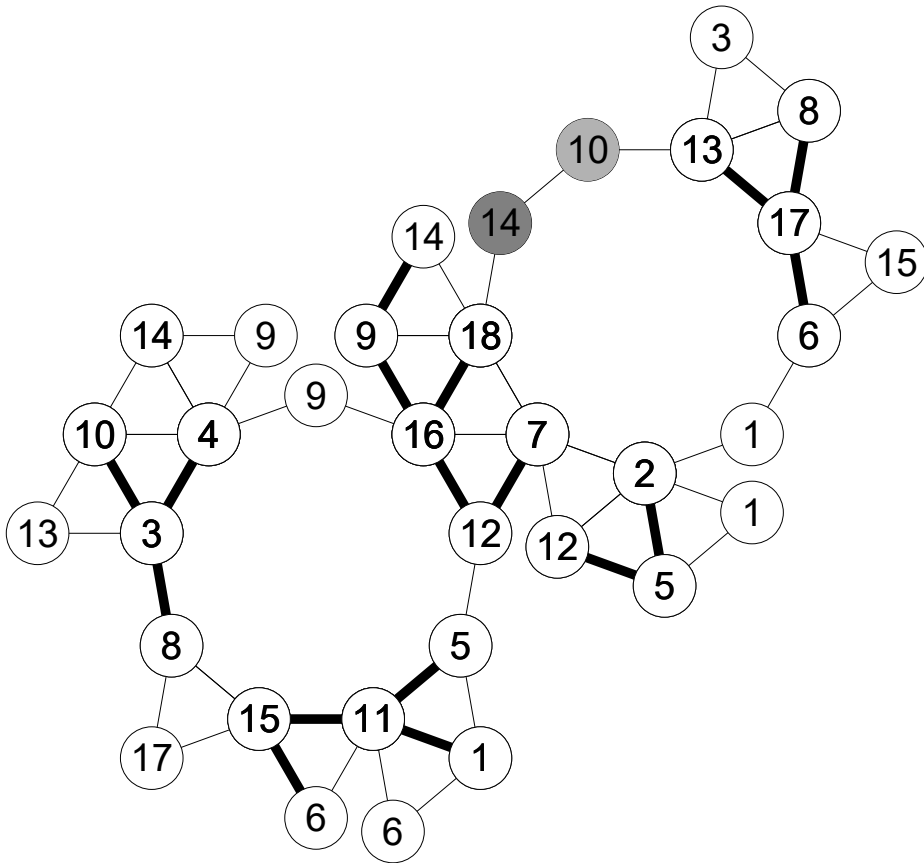

{14, 9, 16, 12, 5, 11, 15, 6, 17, 8, 3, 10}

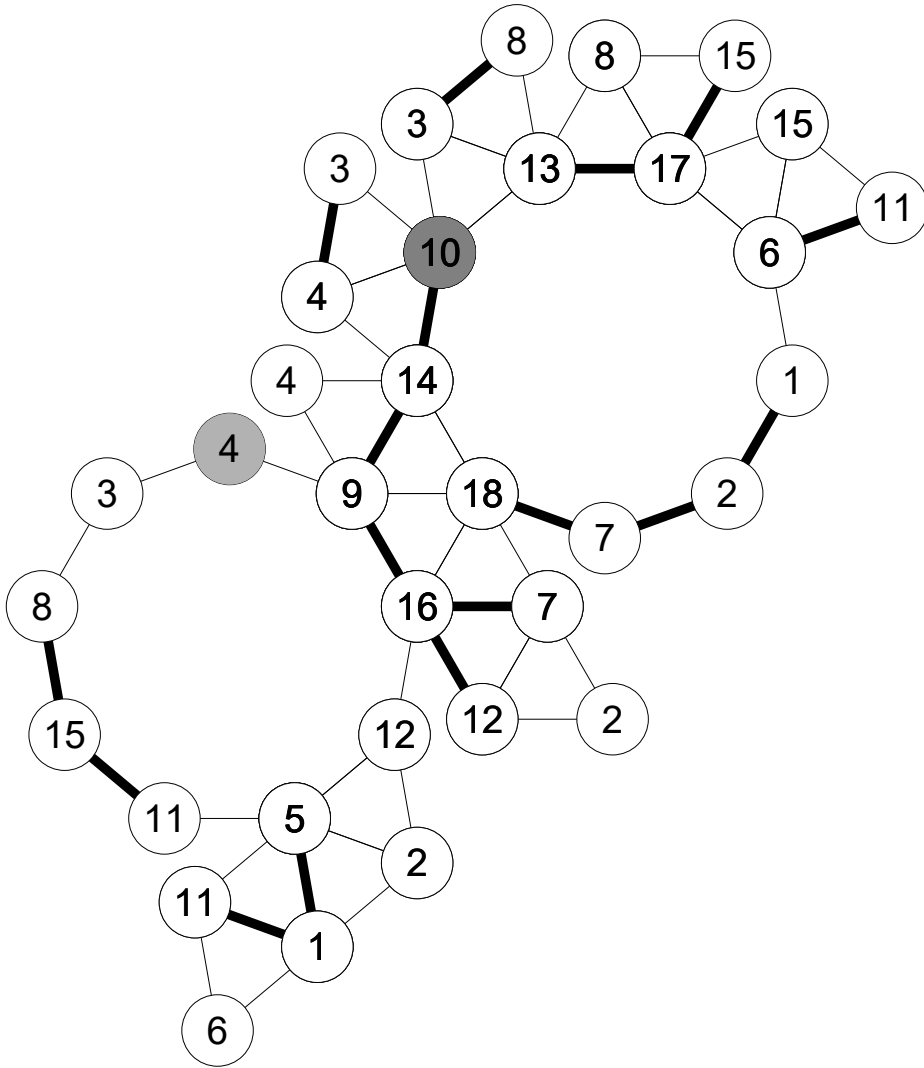

{10, 14, 9, 16, 7, 2, 1, 11, 15, 8, 3, 4}

23

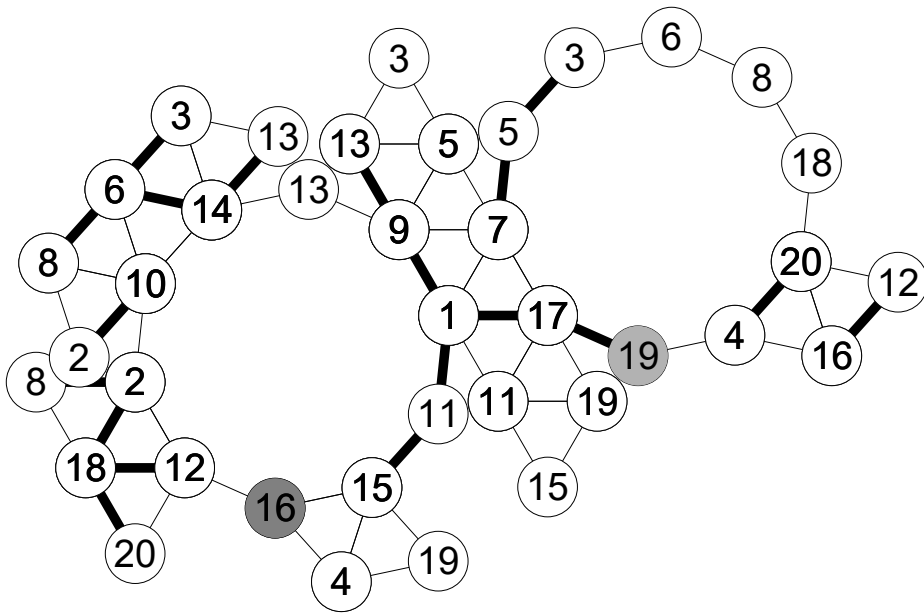

{16, 12, 18, 2, 8, 6, 14, 13, 9, 1, 17, 19}

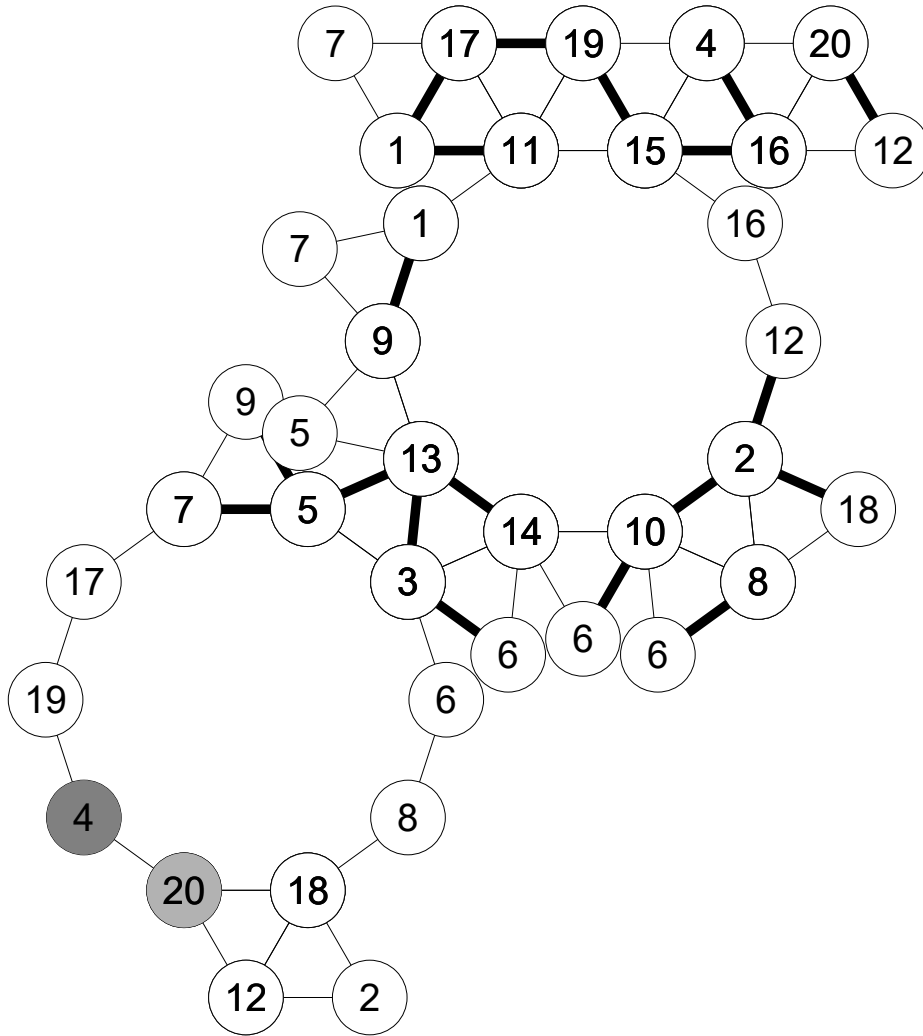

{4, 16, 15, 19, 17, 1, 9, 5, 13, 3, 6, 10, 2, 12, 20}



25

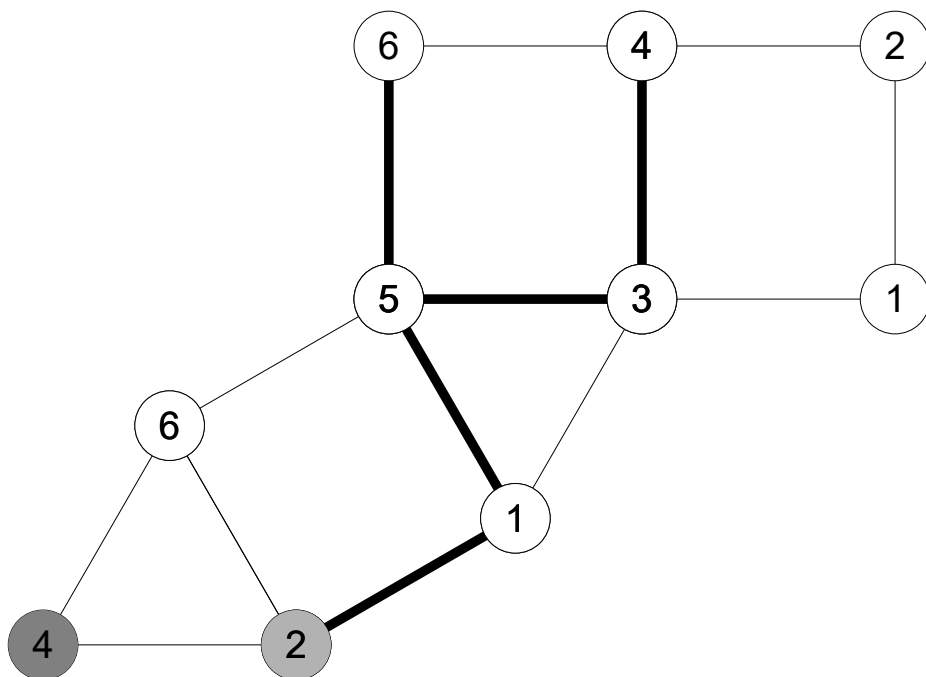

{4, 3, 5, 1, 2}

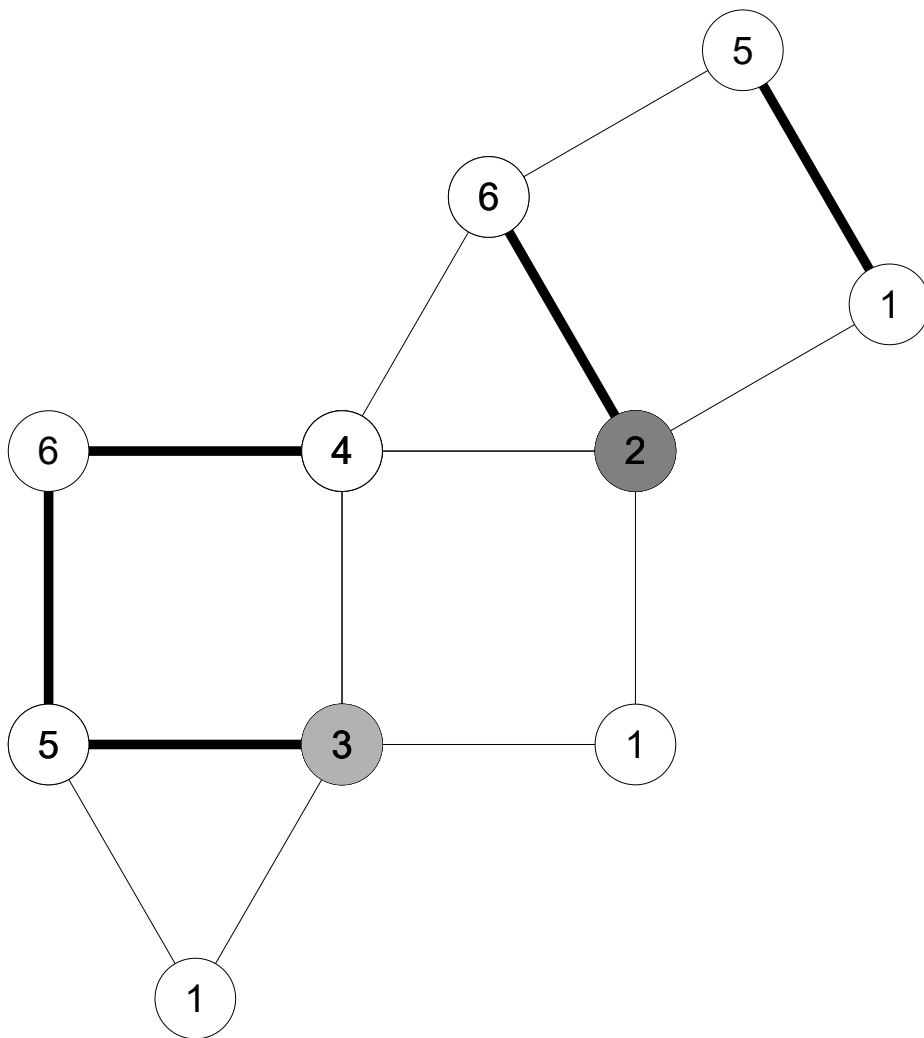

{2, 6, 5, 3}

27

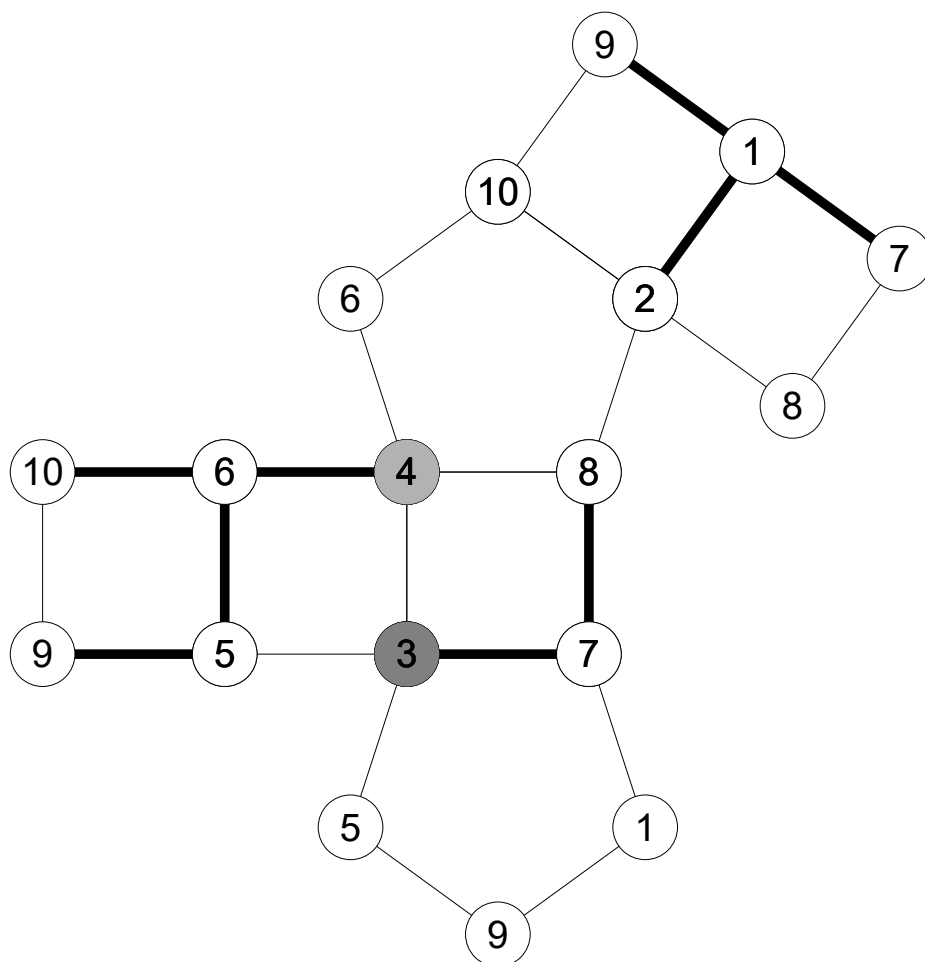

{3, 7, 1, 9, 5, 6, 4}

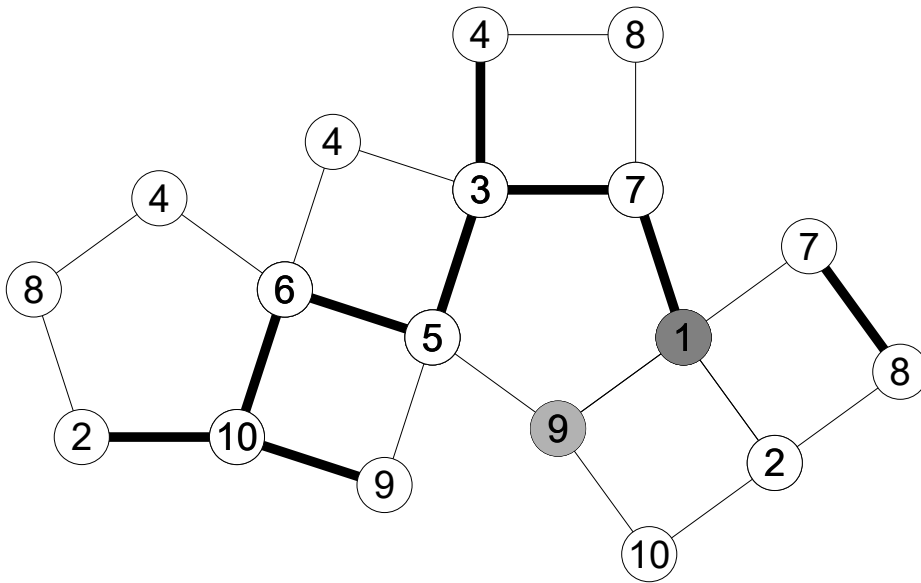

{1, 7, 3, 5, 6, 10, 9}

29

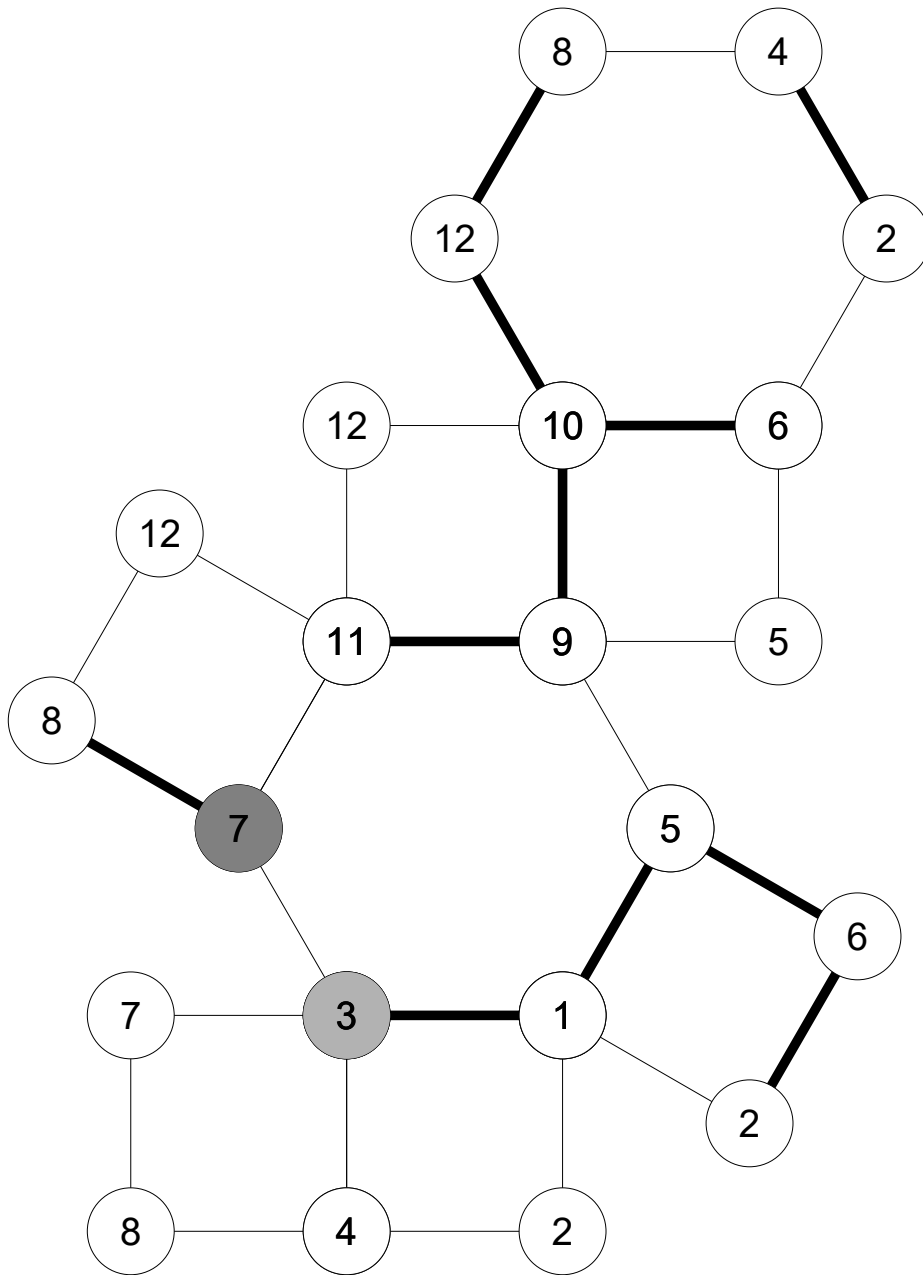

{7, 8, 12, 10, 6, 5, 1, 3}

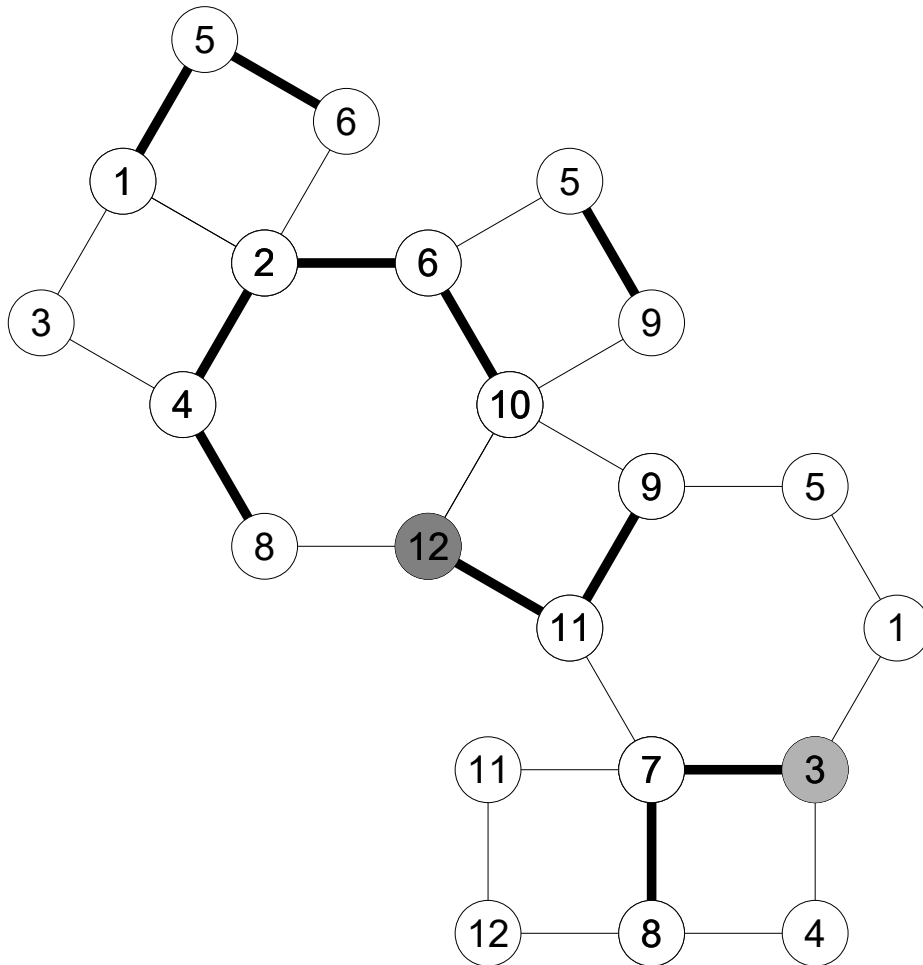

{12, 11, 9, 5, 6, 2, 4, 8, 7, 3}

Referenca : Izidor Hafner "Mazes on the Edges of a Polyhedron"

[http://demonstrations.wolfram.com/MazesOnTheEdgesOfAPolyhedron/Wolfram  
Demonstrations Project](http://demonstrations.wolfram.com/MazesOnTheEdgesOfAPolyhedron/Wolfram%20Demonstrations%20Project)

Published : June 3,  
2014